

# DENON

Hi-Fi Digital Audio Preamplifier

## SERVICE MANUAL MODEL DAP-5500

### DIGITAL AUDIO PREAMPLIFIER



#### TABLE OF CONTENTS

PRECAUTIONS .....	2
SPECIFICATIONS .....	3
NAME OF EACH PART .....	4
REMOVAL OF EACH SECTION .....	5
CONNECTIONS .....	6,7
BLOCK DIAGRAM .....	8
ADJUSTMENT .....	9
BLOCK DIAGRAM OF DIGITAL UNIT .....	10
TIMING CHART .....	11
SAMPLING FREQUENCY INDICATION ADJUSTMENT .....	12
SEMICONDUCTORS .....	13,14
PRINTED WIRING BOARD PARTS LIST .....	15 ~ 20
KU-9102E DIGITAL SIG UNIT	KU-9103E DIGITAL P.S. UNIT
KU-9104E D.A. & INPUT UNIT	KU-9105E ANALOG P.S. UNIT
KU-9116E SERVO UNIT	
PRINTED WIRING BOARD PATTERNS .....	21 ~ 23
KU-9105 ANALOG P.S. UNIT	KU-9102 DIGITAL SIG UNIT
KU-9104 D.A. & INPUT UNIT	KU-9116 SERVO UNIT
KU-9103 DIGITAL P.S. UNIT	
EXPLODED VIEW OF CHASSIS AND CABINET .....	24
PARTS LIST OF EXPLODED VIEW .....	25
WIRING DIAGRAM .....	26
SCHEMATIC DIAGRAM (ANALOG UNIT) .....	27
SCHEMATIC DIAGRAM (DIGITAL UNIT) .....	28

**NIPPON COLUMBIA CO., LTD.**

### Installation Precautions

This device (digital audio device) uses a microcomputer for control of the internal electronic circuits. In the event that this device is used at the same time as a tuner or television, interference could occur either in the sound from the tuner or the picture on the television.

Please take the following precautions to avoid such occurrences.

- Keep this device as far away from the tuner or television as possible.
- Keep the power cable and other cables connected to this device separated from the antenna wires of the tuner or television.
- Interference is particularly likely to occur when an indoor antenna or a 300 ohm feeder line is used, so instead use an outdoor antenna and a 75 ohm coaxial cable for the antenna.

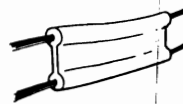

300 ohm feeder line



75 ohm coaxial cable

For U.S.A. and Canada models.

#### CAUTION

TO PREVENT ELECTRIC SHOCK DO NOT USE THIS (POLARIZED) PLUG WITH AN EXTENSION CORD, RECEPTACLE OR OTHER OUTLET UNLESS THE BLADES CAN BE FULLY INSERTED TO PREVENT BLADE EXPOSURE.

For United Kingdom model only.

#### WARNING:

As the colours of the wires in the mains lead of this appliance may not correspond with the coloured markings identifying the terminals in your plug proceed as follows:

The wire which is coloured blue must be connected to the terminal which is marked with the letter N or coloured black. The wire which is coloured brown must be connected to the terminal which is marked with the letter L or coloured red.

The wire which is coloured BROWN must be connected to the terminal which is marked with the letter L or coloured RED.

#### IMPORTANT

The wires in this mains lead are coloured in accordance with the following code:

Blue: Neutral  
Brown: Live

### SPECIFICATIONS

#### ANALOG SECTION

##### Input terminals

Input sensitivity/Input impedance:	LINE-1-2, ] : 1 V/10 kohm	SOURCE DIRECT-ON
	TAPE-1-2 ] 150 mV/10 kohm	SOURCE DIRECT-OFF
	LINE-3 : 1V/10 kohm (Balanced input)	SOURCE DIRECT-ON
	150 mV/10 kohm (Balanced input)	SOURCE DIRECT-OFF
	Suitable input terminals ..... XL type CANNON plugs	

##### Output terminals

Rated output/Impedance:	PRE-OUT-1 : 1 V/10 ohm
	PRE-OUT-2 (Balanced output) : 2 V/600 ohm
	PRE-OUT-1 15 Vrms (Unbalanced-type) 30Vrms (Balanced-type)

##### Maximum output:

##### Frequency response:

1 Hz ~ 300 kHz <sup>+0</sup>/<sub>-3</sub> dB

##### Harmonic distortion:

0.002% 20 Hz ~ 20 kHz 5 V OUT

##### S/N ratio:

116 dB

##### DAC OUT terminals:

Analog output terminals following the D/A converter

##### Output impedance:

470 ohm

##### Output voltage:

2 V (at 10 kohm load, CD max recording level)

NOTE: Specifications are from the regular RCA type unbalanced input/output terminals without specifying "Balanced input/output".

#### DIGITAL SECTION

##### Digital input/output system:

Digital audio interface format

##### Input terminals

###### Optical input terminal:

DIGITAL-1 (1 system)

###### COAXIAL input:

DIGITAL-2 and -3 (2 systems) 0.5 V<sub>p-p</sub>-75 ohm

##### DIGITAL TAPE terminals:

DIGITAL TAPE ..... MONITOR 0.5 V<sub>p-p</sub>-75 ohm

DIGITAL TAPE ..... REC 0.5 V<sub>p-p</sub>-75 ohm

##### D-A conversion method:

4DA push pull- super linear converter

##### Filters:

4-times oversampling digital filter, C.A.L.P, 7-pole analog filter

##### Frequency response:

2 Hz ~ 20 kHz ±0.2 dB

##### S/N ratio:

110 dB

##### Dynamic range:

More than 97 dB

##### Total harmonic distortion:

Less than 0.002% (1 kHz)

##### Channel separation:

More than 100 dB (1 kHz)

#### OTHER FUNCTIONS

##### Automatic switching of sampling

###### frequency:

32 kHz, 44.1 kHz, 48 kHz

##### PRE OUT switch:

ON, OFF

#### GENERAL

##### Power supply/Power consumption:

120 VAC 60 Hz/25 W (for USA, Canada)

220 VAC 50 Hz/25 W (for Europe)

240 VAC 50 Hz/25 W (for UK and Australia)

110/120/220/240 VAC 50/60 Hz/20 W (for Asia ..... multiple)

##### DC Output:

DC 12 V 1 mA

##### Dimensions:

434 mm (17-3/32") W x 133 mm (5-15/64") H x 380 mm (14-61/64") D

##### Weight:

13.7 kg (30 lbs 3 oz)

Specifications and contents are subject to change without notice for purposes of improvement.

NOTE: The following codes correspond to the appropriate models.  
E2 for Europe, EU for U.S.A., EA for Australia, EK for U.K.  
E1 for Asia and EC for Canada.  
This Service Manual is prepared based on EU Black Version.

NAME OF EACH PART

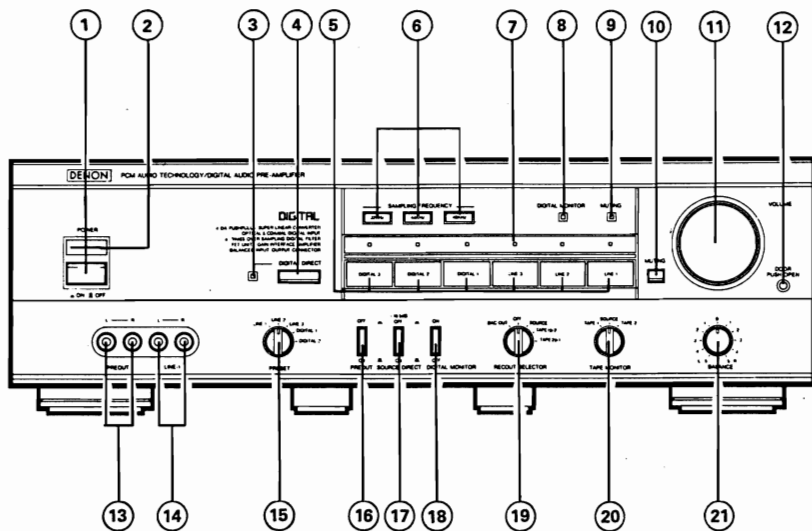

- |                                                      |                                               |
|------------------------------------------------------|-----------------------------------------------|
| ① POWER (Power switch)                               | ⑫ DOOR (Door-open button)                     |
| ② POWER (Power "ON" indication)                      | ⑬ PRE OUT (PRE OUT output side terminals)     |
| ③ DIGITAL DIRECT (Digital direct indication)         | ⑭ LINE-1 (LINE-1 input side terminals)        |
| ④ DIGITAL DIRECT (Digital direct switch)             | ⑮ PRESET (Preset switch)                      |
| ⑤ INPUT SELECTOR (Input selector switch)             | ⑯ PRE OUT (PRE OUT off switch)                |
| ⑥ SAMPLING FREQUENCY (Sampling frequency indication) | ⑰ SOURCE DIRECT (Source direct switch)        |
| ⑦ INPUT SELECTOR (Input selector indication)         | ⑱ DIGITAL MONITOR (Digital monitor switch)    |
| ⑧ DIGITAL MONITOR (Digital monitor indication)       | ⑲ REC OUT SELECTOR (REC OUT selection switch) |
| ⑨ MUTING (Muting indication)                         | ⑳ TAPE MONITOR (Tape monitor switch)          |
| ⑩ MUTING (Muting switch)                             | ㉑ BALANCE (Balance control)                   |
| ⑪ VOLUME (Volume control)                            |                                               |

REMOVAL OF EACH SECTION

1. Top Covers (L), (R)

Remove the 4 screws each from the top covers, and lift the covers to remove.

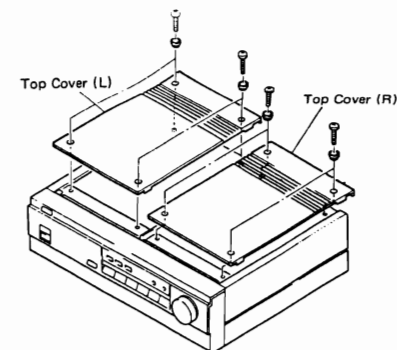

2. Bottom Covers (L), (R)

Unfasten the 8 screws each from the bottom covers, and lift the covers to remove.

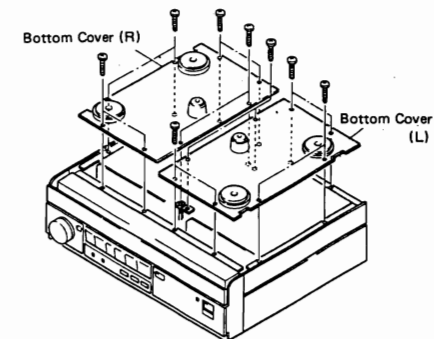

3. Front Panel

- 1) Remove the set screw tightening the main volume control knob, and detach the knob.
- 2) Pull out the power switch knob.
- 3) Unfasten the 4 screws from the top side and the 2 screws from the bottom side.
- 4) Draw the front panel toward you to remove.

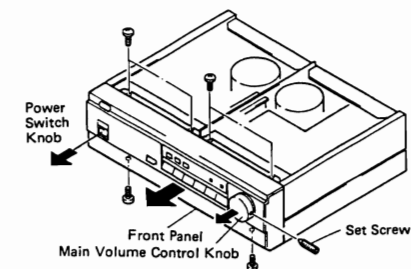

4. Rear Panel

- 1) Remove 2 screws (A).
- 2) Unfasten 17 screws (B) on the rear panel.
- 3) Draw the rear panel toward you to remove.

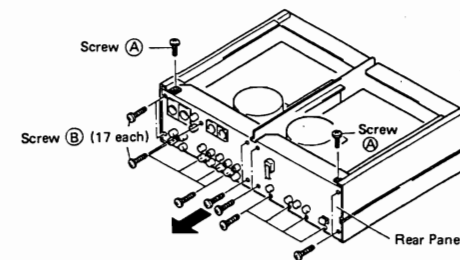

CONNECTIONS

● Precautions for Preamp Installation

Taking into consideration the heat given off by a power amp, install this unit according to the guidelines shown in the diagram.

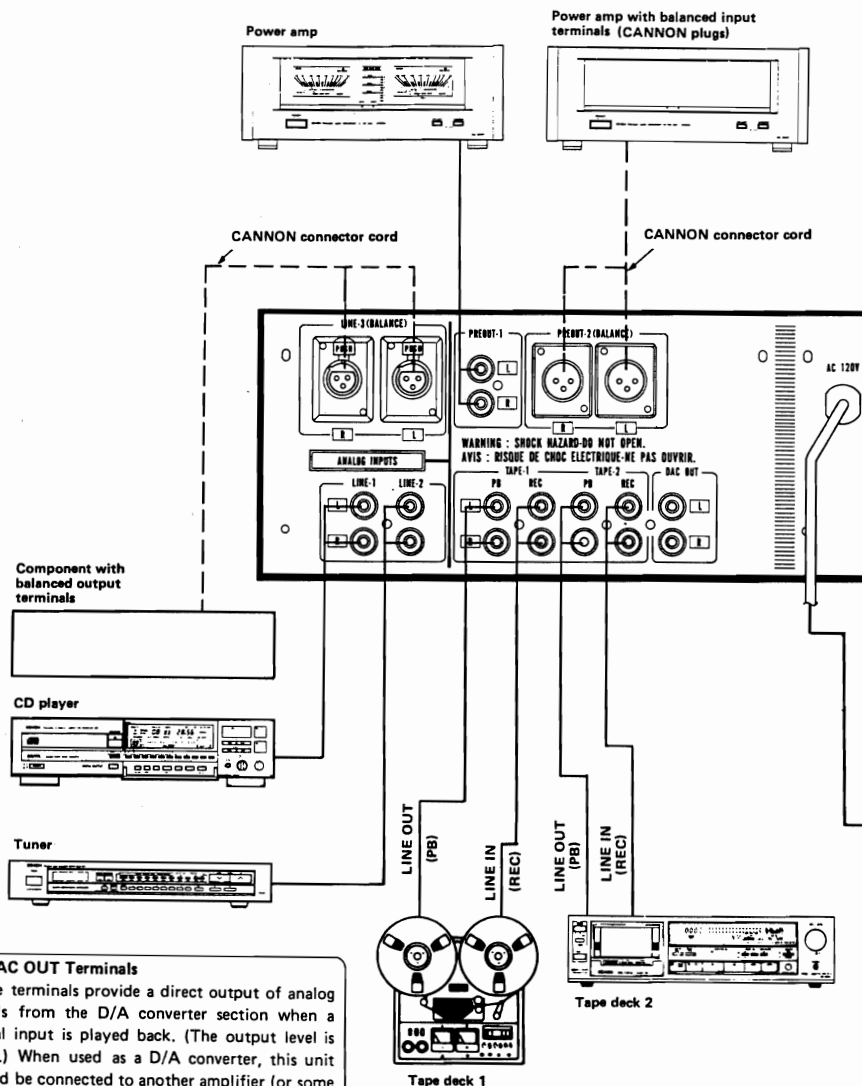
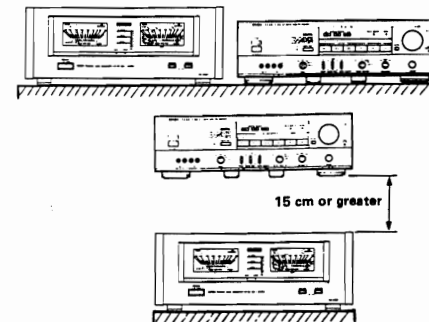

**DAC OUT Terminals**  
 These terminals provide a direct output of analog signals from the D/A converter section when a digital input is played back. (The output level is fixed.) When used as a D/A converter, this unit should be connected to another amplifier (or some other audio component).

This terminal is remote control, DC power outlet used to drive the power switch to the power amplifier system. It is a dual channel outlet with a left and right channel.

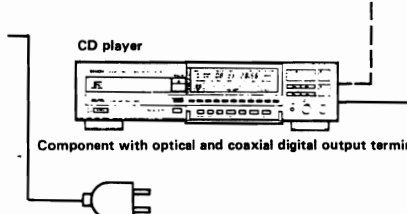
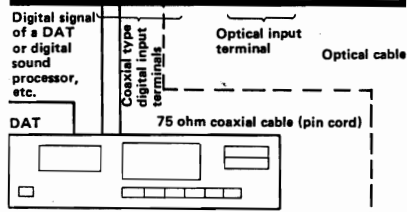
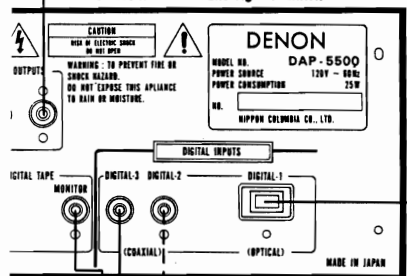

This figure shows the back panel for models with U.S. and Canada specifications. Labels on the panel differ slightly depending on the destination country.

● **LINE VOLTAGE** (Voltage select switch) . . .  
 For Multiple voltage model only.

- The desired voltage may be set with the VOLTAGE SELECTOR KNOB on the back panel using a screw driver.
- Do not twist the VOLTAGE SELECTOR KNOB with excessive force. It may be damaged.
- If the voltage select switch does not turn smoothly, see a qualified serviceman.

**Precautions for Connections**

- Do not plug in the power cord until all connections have been completed.
- Connect L to L and R to R after checking the left and right channels.
- Insert the power plug firmly. An incomplete connection will lead to the generation of noise.
- Do not bind the pin plug cord and the power cord together or set the pin plug cords near a power transformer since this arrangement will cause hum or noise.
- Be sure to insert the optical connector protection caps when not using optical cable.
- LINE-1 input terminals are provided on the front and back panels. Connect only one of these sets of terminals – either the back or the front.

BLOCK DIAGRAM

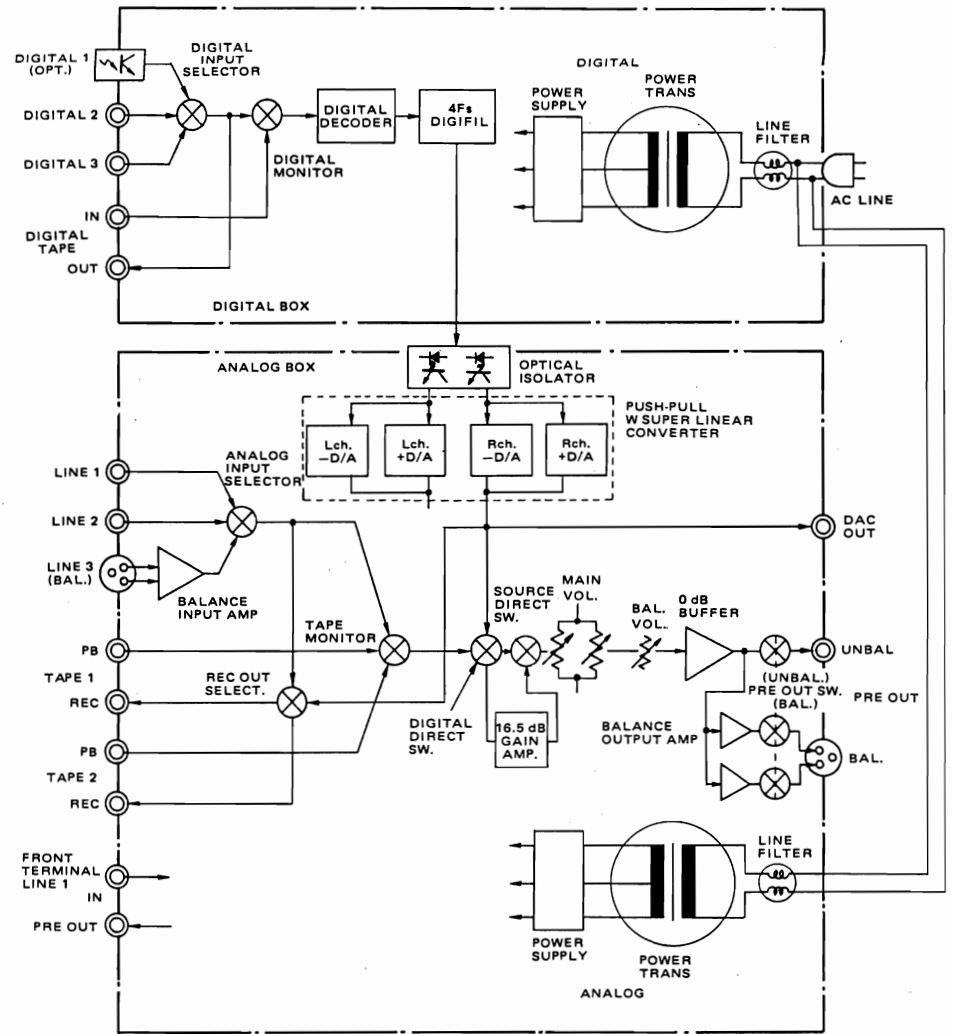

**ADJUSTMENT**

• **BOOST AMP Neutral Point Adjustment**

- 1) Turn the power switch ON.
- 2) Set the INPUT SELECTOR to LINE-2.
- 3) Turn the DIGITAL DIRECT switch OFF.
- 4) Insert the short-pin to both L and R of LINE-2.
- 5) Connect a digital DC voltmeter across the KU-9103-4 TP terminal L and KU-9105-1 common plate, and adjust VR301 to obtain  $0 \pm 0.1$  mV indication on the meter.
- 6) Connect a digital DC voltmeter across the KU-9103-4 TP terminal R and KU-9105-1 common plate, and adjust VR302 to obtain  $0 \pm 0.1$  mV indication on the meter.

• **UGI AMP Neutral Point Adjustment**

- 1) Turn the power switch ON.
- 2) Set the VR001 (volume control) to MIN position.
- 3) Wait 3 minutes or more to warm-up, adjust VR011 and VR012 to obtain  $0 \pm 0.1$  mV DC voltage at PRE OUT-1 on the digital DC voltmeter.

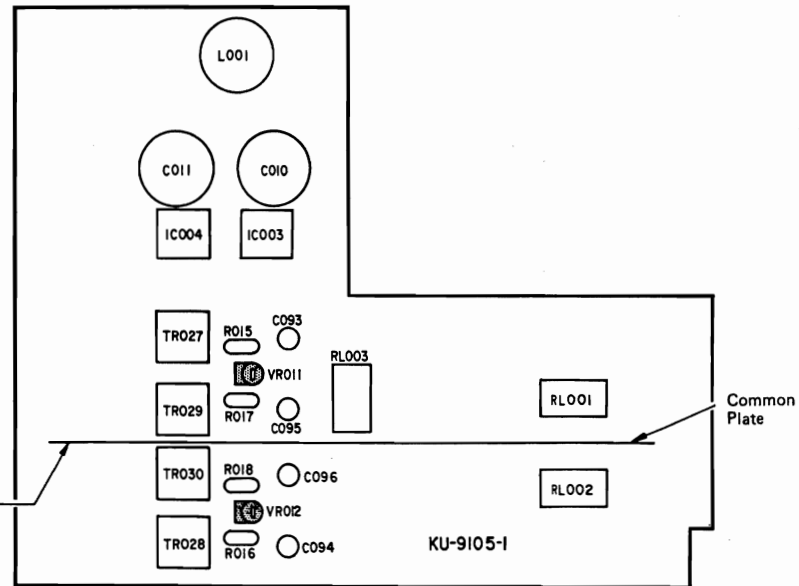
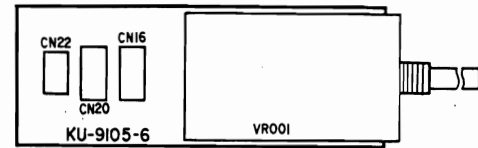
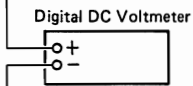
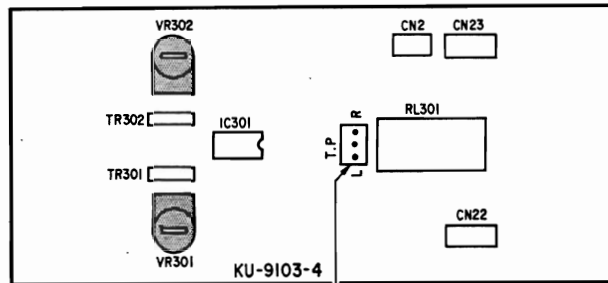

BLOCK DIAGRAM OF DIGITAL UNIT

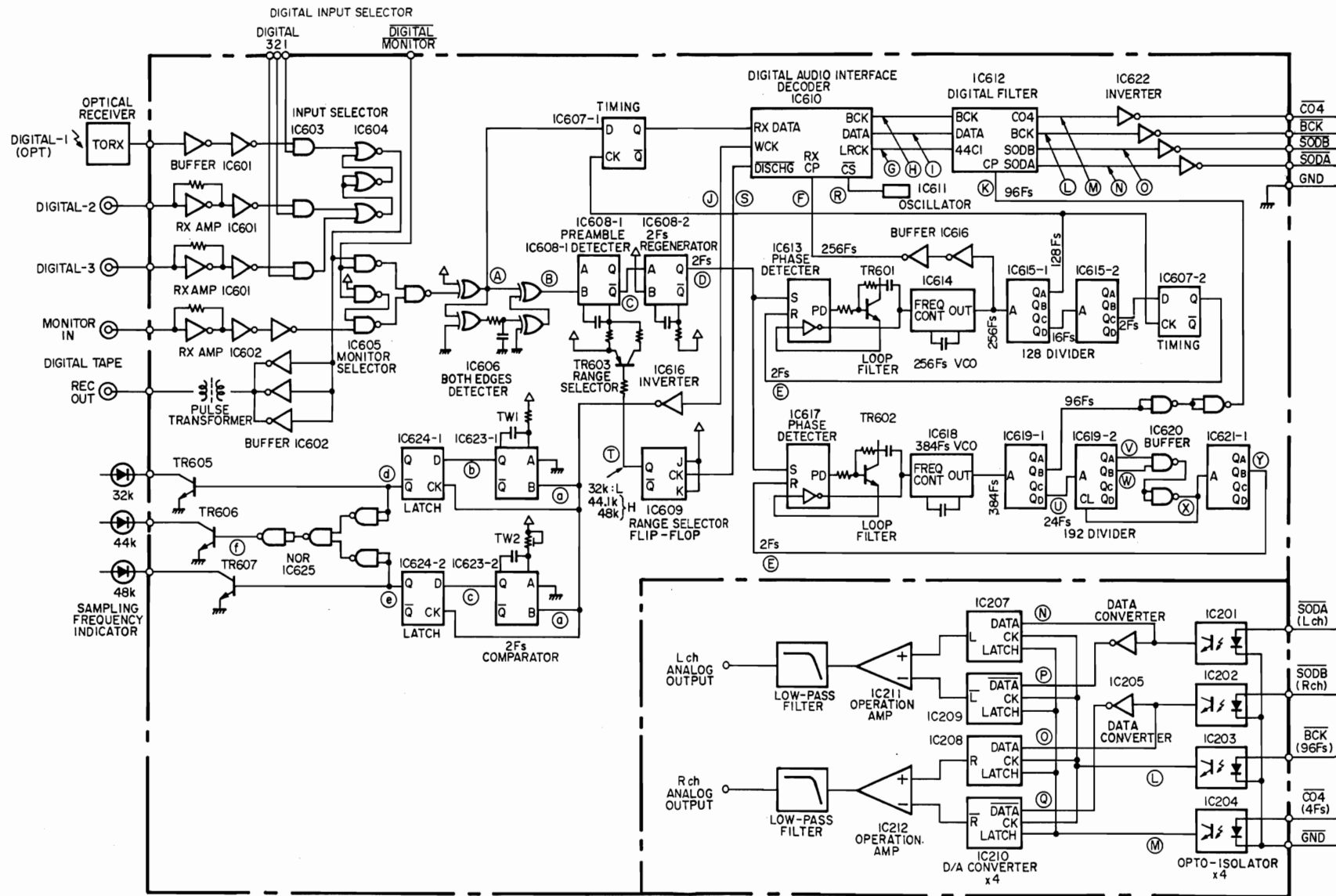

TIMING CHART

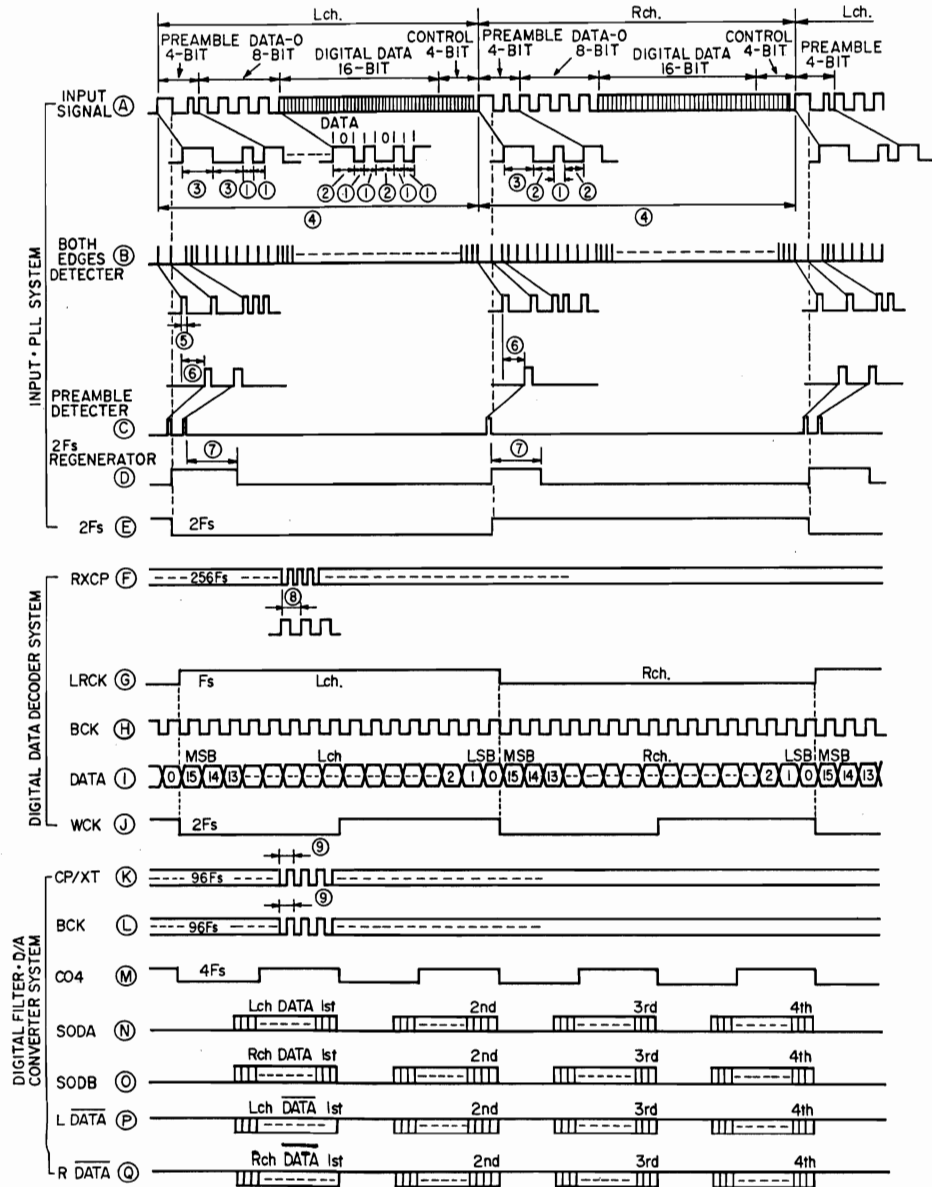

NO.	Fs	Pulse Width of Each Waveform			Unit
		32k	44.1k	48k	
①	244n	177n	163n		sec.
②	488n	354n	326n		
③	732n	531n	488n		
④	15.6μ	11.3μ	10.4μ		
⑤		60-70n			
⑥	650n	410n			
⑦		3.0μ			
⑧	122n	89n	81n		
⑨	326n	236n	217n		

Fs: Sampling Frequency

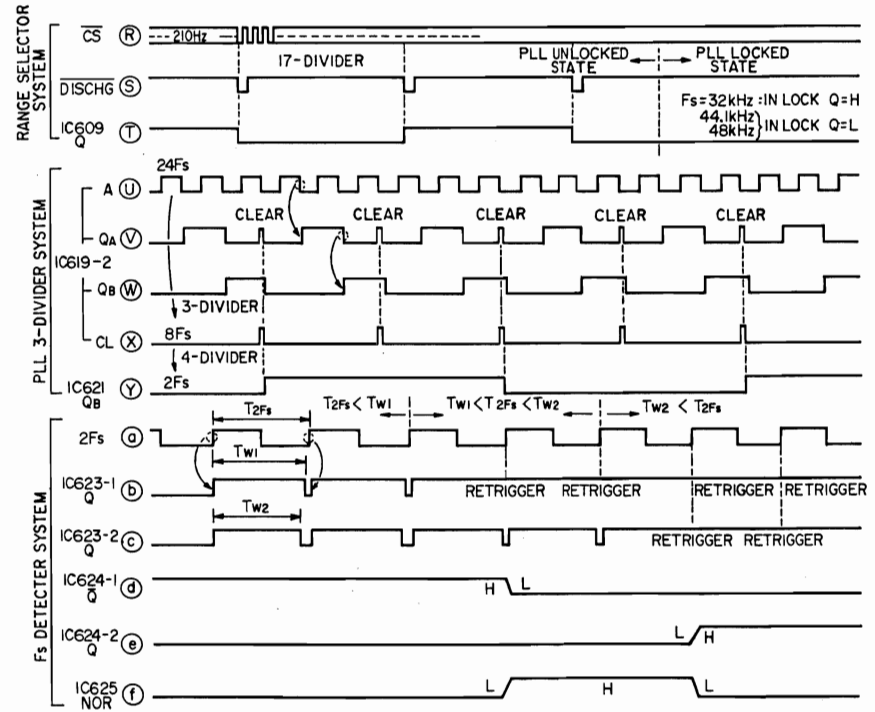



### SAMPLING FREQUENCY INDICATION ADJUSTMENT

This unit automatically discriminates the sampling frequency in the input digital signal.  
 The input sampling frequency to the indication relates roughly as follows:

F <sub>sin</sub> Input Sampling Frequency	Sampling Frequency Indication
F <sub>sin</sub> < 38 kHz	32 kHz
38 kHz < F <sub>sin</sub> < 46 kHz	44 kHz
46 kHz < F <sub>sin</sub>	48 kHz

Switching of 32 kHz and 44 kHz indication is performed by the fixed constant (R641 and C661). However, for 44 kHz and 48 kHz is performed by VR601 adjustment.

#### 1. Adjustment Procedure for Connecting a CD Player Equipped with the Digital Output

- 1) Connect a digital output from the CD player to the digital input of this unit (CD player digital output: ON, CD soft not required) and set the unit in operation mode.
- 2) Connect an oscilloscope across TP. 1 and TP. 2 on the digital signal P.W. Board KU-9102 and observe 5V logic waveform.
- 3) As rotating VR601 on the KU-9102 shifts the waveforms A → B → C, make the adjustment so that the duty ratio for 1 cycle becomes 96% (refer to the Figure below).

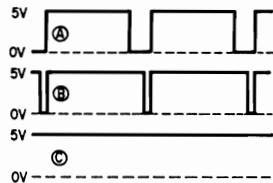

Duty ratio =  $\frac{T_H}{T} \times 100(\%)$

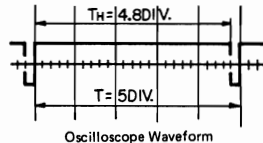

T : Adjust time axis of the scope for 5DIV.  
 TH: Adjust VR601 for 4.8DIV.

- 4) Upon completion of adjustment, verify that 44 kHz indication is properly lit.

#### 2. Adjustment Procedure for Using a Pulse Generator

In case of a CD player equipped with the digital output is not available, use a pulse generator for adjustment.

- 1) Remove either one of the sides of J74 on the KU-9102. (Be sure that the removed part does not touch any other portion.)
- 2) Apply a 5Vp-p, 88.2 kHz square wave output from the pulse generator to TP. 4 and TP. 2 (GND).
- 3) In the same manner as to "1. Adjustment Procedure", follow the step from 2) to adjust the frequency of the pulse generator so that the indication shifts from 44 kHz to 48 kHz at  $92.1 \pm 1$  kHz.
- 4) Disconnect the measuring equipment and re-solder J74 as it was before.

### CONNECTION OF MEASURING EQUIPMENT

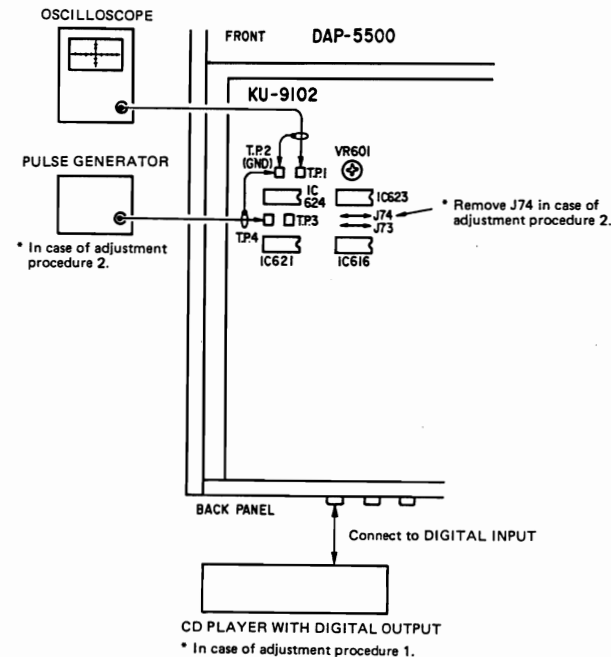

SEMICONDUCTORS

• IC

HD14001BP  
HD74HC02P  
HD74HC02P  
HD74HC08P  
HD74HC74P  
HD74HC86P  
HD74LS393P  
(Hitachi)  
TC74HCU04P  
(Toshiba)

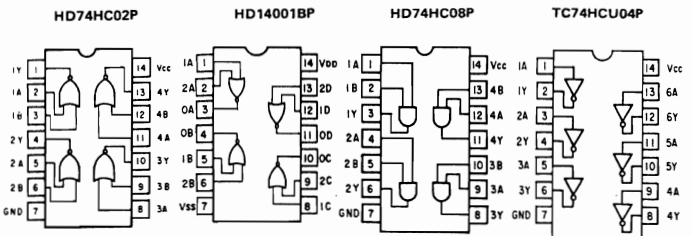

TC5081AP  
(Toshiba)

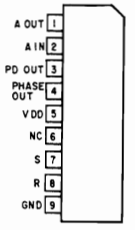

M5238P (Mitsubishi)  
LA6458DF (Sanyo)

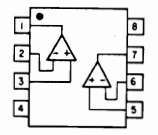

M5219P  
(Mitsubishi)

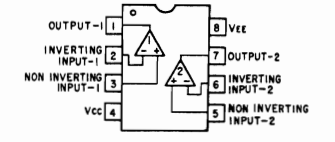

HD74HC74P

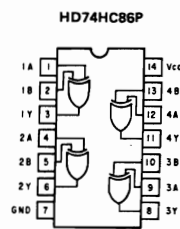

HD74HC86P

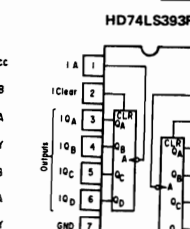

HD74HC00P

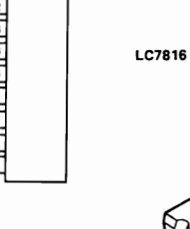

HD74LS393P

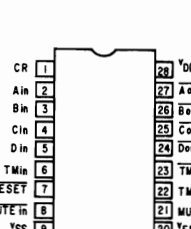

HD74LS112P  
HD74LS123P  
(Hitachi)

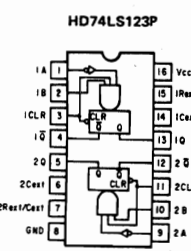
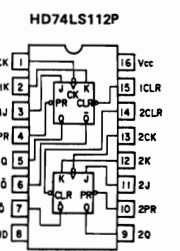

SN74LS624N  
(Texas Instruments)

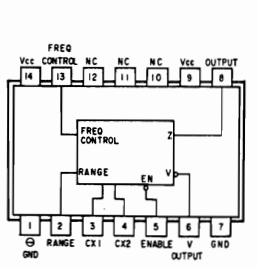

LC7816 (Sanyo)

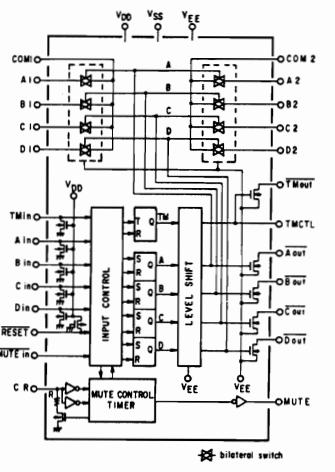
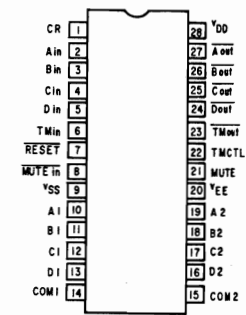

AN79N05  
AN79N24  
(Matsushita)

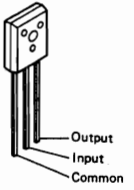

AN78N05  
AN78N24  
(Matsushita)

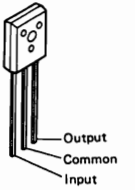

SMS804D  
(NPC)

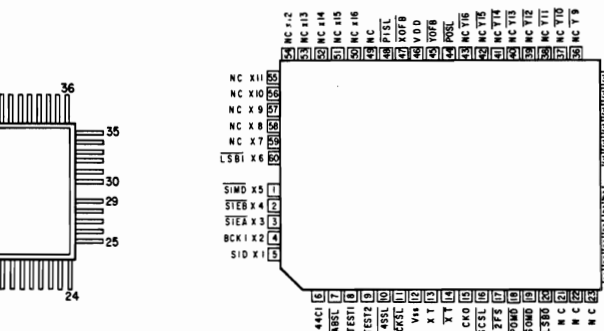

NJM2068DA  
(JRC)

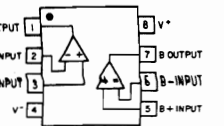

NJM555D  
(JRC)

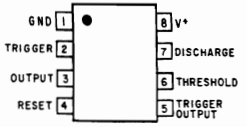

L78M15ML  
L78M05ML  
(Sanyo)

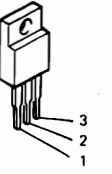

NJM78M05A  
NJM78M12A  
(JRC)

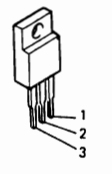

NJM79M05A  
NJM79M12A  
NJM79M15A  
(JRC)

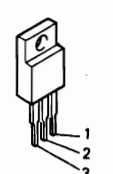

PCM56KP  
(Bar Brown)

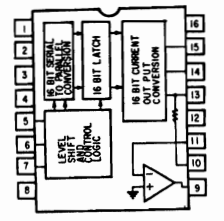
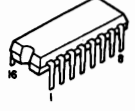

TD62553S  
(Toshiba)

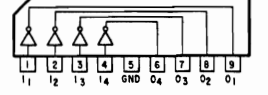
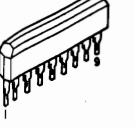

CXD1076P  
(SONY)

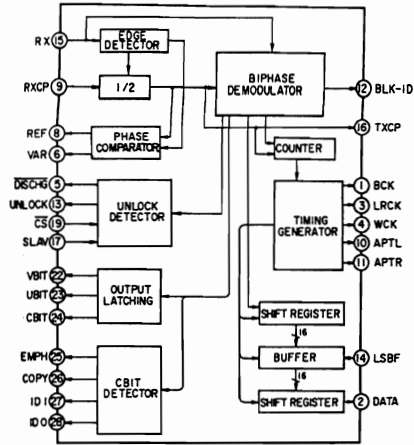
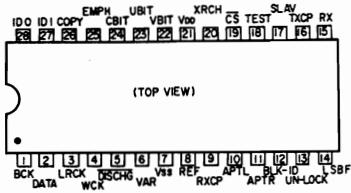
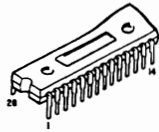

TERMINAL DESCRIPTION

Terminal No.	I/O	Terminal Symbol	Terminal Description
1	O	BCK	Shift clock output of digital audio data.
2	O	DATA	Serial output of decoded audio data.
3	O	LRCK	Discriminating pulse for L/R channel in audio data. Polarity is switchable with XRCH terminal. XRCH in "L" for Rch in High.
4	O	WCK	Pulse which has a frequency twice higher as LRCK. Output signifies 1 word punctuation. Up to all-down of the pulse composing 1 word.
5	O	DISCHG	Low-active pulse output to perform as a locking trigger at the time clock pick-up external PLL becomes unlock condition.
6	O	VAR	Low-active pulse output to make decision of sink current for external PLL.
7	-	VSS	GND terminal.
8	O	REF	High-active pulse output to make decision of source current for external PLL.
9	I	RXCP	Clock input which has a 256 times greater than the fs as picked up by external PLL.
10	O	APTL	Pulse output for operation compensation.
11	O	APTR	Pulse output for operation compensation.
12	O	BLK-ID	BLOCK detection panel output for synchronizing the head of C-bit BLOCK.
13	O	UNLOCK	Detection output of designating PLL in LOCK condition. In "L" is locked.
14	I	LSBF	Input for switching higher or lower in the head of audio data serial output. "H": LSB first, "L": MSB first.
15	I	RX	Input for digital I/O data which is decoded by digital audio interface format.
16	O	TXCP	Clock output of 128fs to be used as a master clock for auxiliary equipment.
17	I	SLAV	Terminal to shift output terminals of data TXCP, WCK, LRCK, BCK for Hi-z. "L": Normal state, "H": Hi-z state.
18	I	TEST	Input for switching TEST mode and Normal mode. "H": TEST mode, "L": Normal mode.
19	I	CS	Clock input to produce DISCHG needed for external PLL.
20	I	XRCH	Input for making the decision of LR clock polarity. "H": Lch High, Rch Low. "L": Lch Low, Rch High.
21	-	VDD	Power supply terminal.
22	O	VBIT	Validity Flag (V-bit) output.
23	O	UBIT	User Definable Data (U-bit) output.
24	O	CBIT	Channel Status Data (C-bit) output.
25	O	EMPH	Output of Emphasis data. "H" to ON.
26	O	COPY	Output of COPY Inhibit data. "L" to Inhibit.
27	O	ID1	ID1 output.
28	O	ID0	ID0 output.

HCPL-2601

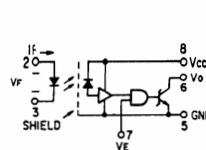

TORX172

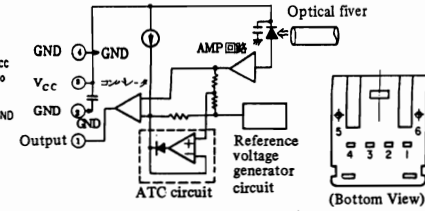

Pin No.	Connection
1	output
2	GND
3	Vcc
4	GND
5	Case(1)
6	Case(1)

TRANSISTORS

2SC1815(BL)  
2SC2878(A/B)  
2SA1015(GR)

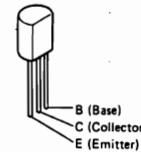

RN1202(10K-10K)NPN  
RN2202(10K-10K)PNP

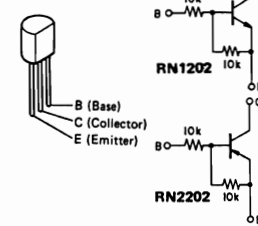

2SK184(Y)

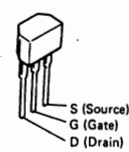

2SC2458(BL)  
2SA1048(GR)

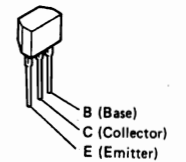

2SA968(Y)  
2SC2238(Y)

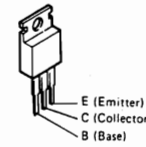

2SB647A

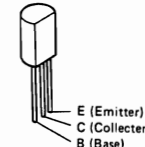

2SJ748L  
2SK170BL

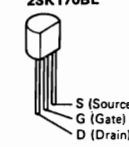

2SK389(GR)/(BL)/(V)

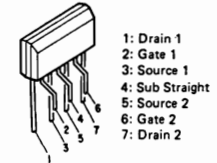

DIODES

IS2076A



ISS270A

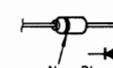

HZ5C-1  
HZ6C-3  
HZ7B-3  
HZ15-2



DSA1A2-Type-3



SEL-1210S  
SEL-1410E  
SEL-1810A



SLF-206B



LD-701DU

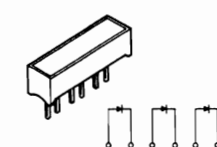

PRINTED WIRING BOARD PATTERNS AND PARTS LIST

KU-9102E DIGITAL SIG UNIT

Ref. No.	Part No.	Part Name	Remarks
<b>SEMICONDUCTORS GROUP</b>			
IC601,602	2620739005	TC74HCU04P	
IC603	2620729002	HD74HC08P	
IC604	2620655008	HD74HC02P	
IC605	2620591007	HD74HC00P	
IC606	2620724007	HD74HC86P	
IC607	2620594004	HD74HC74P	
IC608	2620537003	HD74LS123P	
IC609	2620834007	HD74LS112P	
IC610	2620833008	CXD1076P	
IC611	2630458004	NJM555D	
IC612	2620734000	SM5804D	
IC613	2620738006	TC5081AP	
IC614	2620824004	SN74LS624N	
IC615	2620544009	HD74LS393P	
IC616	2620739005	TC74HCU04P	
IC617	2620738006	TC5081AP	
IC618	2620924004	SN74LS624N	
IC619	2620544009	HD74LS393P	
IC620	2620591007	HD74HC00P	
IC621	2620544009	HD74LS393P	
IC622	2620739005	TC74HCU04P	
IC623	2620537003	HD74LS123P	
IC624	2620594004	HD74HC74P	
IC625	2620591007	HD74HC00P	
TR601,602	2730198015	2SC1815 (BL)	
TR603	2710102021	2SA1015 (GR)	
TR604~607	2730198015	2SC1815 (BL)	
TR608	2710102021	2SA1015 (GR)	
D601,602	2760432000	1SS270A	
<b>RESISTOR GROUP (not included Carbon Film ±5%,¼W type)</b>			
R616	2452369960	RN14K2E153F	15kΩ, ¼W (±1%)
R617	2452370933	RN14K2E303F	30kΩ, ¼W (±1%)
R620	2452320006	RN14K2E103F	10kΩ, ¼W (±1%)
R641	2452370933	RN14K2E303F	30kΩ, ¼W (±1%)
R642	2452369960	RN14K2E153F	15kΩ, ¼W (±1%)
VR601	EP-5462H15	SOLID VR	22kΩ, FS
<b>CAPACITORS</b>			
C601~604	2531024003	CK45F1H103Z	0.01μF/50V
C605	2544254006	CE04W1C100M	10μF/16V
C606	2531024003	CK45F1H103Z	0.01μF/50V
C607	2544256020	CE04W1E330M	33μF/25V
C608	2531024003	CK45F1H103Z	0.01μF/50V

Ref. No.	Part No.	Part Name	Remarks
C609	2544256020	CE04W1E330M	33μF/25V
C610	2531024003	CK45F1H103Z	0.01μF/50V
C611	2544256020	CE04W1E330M	33μF/25V
C612	2531024003	CK45F1H103Z	0.01μF/50V
C613	2544256020	CE04W1E330M	33μF/25V
C614~617	2531024003	CK45F1H103Z	0.01μF/50V
C618	2533617007	CC45SL1H390J	39pF/50V
C619	2556171025	CQ09S1H680G	68pF/50V
C620	2556171009	CQ09S1H681G	680pF/50V
C621 622	2531024003	CK45F1H103Z	0.01μF/50V
C623	2544254006	CE04W1C100M	10μF/16V
C625	2531024003	CK45F1H103Z	0.01μF/50V
C626	2561035017	CF93A1H224J	0.22μF/50V
C627~629	2531024003	CK45F1H103Z	0.01μF/50V
C630	2544254006	CE04W1C100M	10μF/16V
C631~633	2531024003	CK45F1H103Z	0.01μF/50V
C634	2544252066	CE04W1A471M	470μF/10V
C635	2531024003	CK45F1H103Z	0.01μF/50V
C636	2544254006	CE04W1C100M	10μF/16V
C637	2531024003	CK45F1H103Z	0.01μF/50V
C638	2531001000	CK45B1H331K	330pF/50V
C639	2561034047	CF93A1H563J	0.056μF/50V
C640	2551120084	CQ93M1H472J	4700pF/50V
C641	2531024003	CK45F1H103Z	0.01μF/50V
C642	2521026008	CM92C1H470J	47pF/50V
C643	2531024003	CK45F1H103Z	0.01μF/50V
C644	2544254006	CE04W1C100M	10μF/16V
C645~648	2531024003	CK45F1H103Z	0.01μF/50V
C649	2544254006	CE04W1C100M	10μF/16V
C650	2531024003	CK45F1H103Z	0.01μF/50V
C651	2531055056	CK45B1H221K	220pF/50V
C652	2561034047	CF93A1H563J	0.056μF/50V
C653	253643000	CC45SL1H471J	470pF/50V
C654	2531024003	CK45F1H103Z	0.01μF/50V
C655,656	2544162017	CE04W1A331M	330μF/10V
C657	2521020004	CM92C1H270J	27pF/50V
C658~660	2531024003	CK45F1H103Z	0.01μF/50V
C661	2556171012	CQ09S1H102G	1000pF/50V
C662	2551120000	CQ93M1H102J	1000pF/50V
C663	2544254006	CE04W1C100M	10μF/16V
C664~666	2531024003	CK45F1H103Z	0.01μF/50V
C667	2544254006	CE04W1C100M	10μF/16V
C668,669	2531024003	CK45F1H103Z	0.01μF/50V
C670	2544254006	CE04W1C100M	10μF/16V
C672	2531002009	CK45B1H471K	470pF/50V
C673	2531002009	CK45B1H471K	470pF/50V
C674	2533619005	CC45SL1H470J	47pF/50V
C675	2531024003	CK45F1H103Z	0.01μF/50V
C676	2531004007	CK45B1H102K	1000pF/50V
C677	2531024003	CK45F1H103Z	0.01μF/50V
C678	2531004007	CK45B1H102K	1000pF/50V
<b>TRANS, COIL</b>			
T601	2318058001	PULSE TRANS	

KU-9103E DIGITAL P.S. UNIT

Ref. No.	Part No.	Part Name	Remarks
L601	2350016920	INDUCTOR	47μH ±10%
L603,604	2350015989	INDUCTOR	4.7μH ±10%
L606~617	2350015989	INDUCTOR	4.7μH ±10%
L619~627	2350015989	INDUCTOR	4.7μH ±10%
<b>OTHER PARTS GROUP</b>			
	2048234001	1P CONNECTOR BASE	
	2048235000	3P CONNECTOR BASE	
	2050141027	COMMON PLATE	
	2050185041	4P WIRE HOLDER	
	2050185054	5P WIRE HOLDER	
	2050190052	5P NH CONNECTOR BASE	
	2030241028	1P CONTACT ASS'Y	
	2038188002	5P CONNECTOR CORD	
	2042211004	8P CONNECTOR CORD	
	2690044005	TORX-172	

Ref. No.	Part No.	Part Name	Remarks
<b>SEMICONDUCTOR GROUP</b>			
IC301	2630284003	M5219P	
IC501	2630459003	L78M05ML	
IC502	2630373008	NJM78M12A	
IC503	2630190003	NJM79M12A	
IC504	2620298009	HD14001BP	
IC506	2620841003	TD-62553S	
IC507,508	2620731003	LC7816	
TR301,302	2750045012	2SK389 (GR)/(BL)/(V)	
TR501	2720053005	2SB647A (C)	
TR503	2690025008	RN1202 (10K-10K)	
TR504	2730253015	2SC2878 (A/B)	
TR505	2690025008	RN1202 (10K-10K)	
TR506	2730317003	2SC2458 (BL)	
TR507	2710191003	2SA1048 (GR)	
TR508,509	2730317003	2SC2458 (BL)	
TR510	2710191003	2SA1048 (GR)	
TR511	2730317003	2SC2458 (BL)	
TR512,513	2710191003	2SA1048 (GR)	
TR514	2690025008	RN1202 (10K-10K)	
TR515	2690026007	RN2202 (10K-10K)	
LE501~503	3939362007	SEL-1810A (OR)	
LE504~506	3939362010	SEL-1410E (GR)	
LE507	3939362007	SEL-1810A (OR)	
LE508	3939362023	SEL-1210S (RD)	
LE509	3939362007	SEL-1810A (OR)	
LE510~512	3939364005	SLF-206B (GR) 7 x 19FS	
D301	2760049011	1S2076A	
D501~509	2760427015	DSA1A2 (TYPE-3)	
D511,512	2760049011	1S2076A	
D513	2760173071	HZ6C-3 Zener	
D514	2760254000	HZ7B-3 Zener	
D515	2760049011	1S2076A	
D516	2760254000	HZ7B-3 Zener	
D517~523	2760049011	1S2076A	
D525~534	2760049011	1S2076A	
D540	2760049011	1S2076A	
<b>RESISTOR GROUP (not included Carbon Film ±5%, ¼W type)</b>			
VR301,302	2116025016	V08PB101 Semi Fixed Resistor	100Ω
<b>CAPACITOR GROUP</b>			
C303,304	2554216018	CO09P1H472J	4700pF/50V
C305,306	2543056014	CE04D1H010MBP	1μF/50V
C309,310	2544258918	CE04W1V100M	10μF/35V

Ref. No.	Part No.	Part Name	Remarks
C501,502	2538014003	CK45F2GAC103M	0.01μF/400V AC
C504	2551134025	CQ92M1H103J	0.01μF/50V
C505	2531052004	CK45E2H472P	4700pF/500V
C506	2544256091	CE04W1E222M	2200μF/25V
C507	2544254019	CE04W1C220M	22μF/16V
C508,509	2544231003	CE04W1C101M	100μF/16V
C510,511	2544256091	CE04W1E222M	2200μF/25V
C512	2544254048	CE04W1C101M	100μF/16V
C513,514	2544258057	CE04W1V101M	100μF/35V
C515	2544254048	CE04W1C101M	100μF/16V
C516	2544260045	CE04W1H010M	1μF/50V
C517	2531006005	CK45B1H222K	2200pF/50V
C518,519	2531004007	CK45B1H102K	1000pF/50V
C520	2531006005	CK45B1H222K	2200pF/50V
C521	2544260045	CE04W1H010M	1μF/50V
C522,523	2544254006	CE04W1C100M	10μF/16V
C524	2544254022	CE04W1C330M	33μF/16V
C525	2544260032	CE04W1HR47M	0.47μF/50V
C526	2544252037	CE04W1A101M	100μF/10V
C527	2561034076	CF93A1H104J	0.1μF/50V
C528~531	2531024003	CK45F1H103Z	0.01μF/50V
C532	2544254006	CE04W1C100M	10μF/16V
C533	2544258057	CE04W1V101M	100μF/35V
C534,535	2544254048	CE04W1C101M	100μF/16V
C550	2544254006	CE04W1C100M	10μF/16V
C551	2531024003	CK45F1H103Z	0.01μF/50V
C552	2531025002	CK45F1H223Z	0.022μF/50V
<b>RELAY, SWITCH, COIL GROUP</b>			
L501	2398019002	LINE FILTER COIL AC LINE	
RL301,302	2149005100	RELAY (BSR-H-12S)	
SW501~508	2124407008	TACT SWITCH	
SW509	2129547002	3P PUSH SWITCH	
SW512	2123627009	ROTARY SWITCH	
<b>OTHER PARTS GROUP</b>			
	4439023007	LED HOLDER	
	4170253000	RADIATOR	
	4700012022	CROSS PAN SCREW WITH SW. WASHER 3 x 12	
F501~504	2020022008	FUSE HOLDER	
	2061039047	FUSE 1.25A (T)	
	2050141001	COMMON PLATE (EARTH)	
	2050190052	5P NH CONNECTOR BASE	
	2050190081	8P NH CONNECTOR BASE	

Ref. No.	Part No.	Part Name	Remarks
	2050190094	9P NH CONNECTOR BASE	
	2050190036	3P NH CONNECTOR BASE	
	2050233032	3P EH CONNECTOR BASE	
	2050233032	3P EH CONNECTOR BASE	
	2050275016	11P EH CONNECTOR BASE	
	2050275029	12P EH CONNECTOR BASE	
	2050275032	13P EH CONNECTOR BASE	
	2050243022	2P WIRE HOLDER	
	2050185038	3P WIRE HOLDER	
	2050185041	4P WIRE HOLDER	
	2050185054	5P WIRE HOLDER	
	2050185067	6P WIRE HOLDER	
	2034203004	3P CONNECTOR CORD	
	2034382006	3P CONNECTOR CORD	
	2034427000	3P CONNECTOR CORD	
	2034185067	3P CONNECTOR CORD	
	2046139014	11P CONNECTOR CORD	
	2046140003	12P CONNECTOR CORD	
	2046141002	13P CONNECTOR CORD	
	2034415009	3P CONNECTOR CORD	

## KU-9104E D.A. &amp; INPUT UNIT

Ref. No.	Part No.	Part Name	Remarks
<b>SEMICONDUCTOR GROUP</b>			
IC201~204	2620737007	HCPL2601	
IC205	2620739005	TC74HCU04P	
IC206	2630466009	NJM-2068DA	
IC207~210	2620735009	PCM56KP	
IC211,212	2620679000	M-5238P	
IC213,214	2630466009	NJM-2068DA	
IC215	2630468007	L78M15ML	
IC216	2630259009	NUM-79M15A	
IC217	2630471007	AN79N05	
IC218	2630469006	AN78N05	
D201,202	2760432000	1SS270A	
D205~208	2760432000	1SS270A	
<b>RESISTOR GROUP (not included Carbon Film ±5%, %W type)</b>			
VR201~204	EP-5462H19	SOLID VR (104)	100kΩ
<b>CAPACITOR GROUP</b>			
C201~204	2551134025	CQ92M1H103J	0.01μF 50V
C209,210	2544252930	CE04W1A101M	100μF 10V
C211	2544260087	CE04W1H100M	10μF 50V
C212	2531024003	CK45F1H103Z	0.01μF 50V
C213~220	2551134025	CQ92M1H103J	0.01μF 50V
C221~224	2551134038	CQ92M1H223J	0.022μF 50V
C225,226	2554214049	CQ09P1H821J	820pF 50V
C227,228	2554214052	CQ09P1H221J	220pF 50V
C229,230	2554214052	CQ09P1H221J	220pF 50V
C231,232	2554214049	CQ09P1H821J	820pF 50V
C233,234	2554214052	CQ09P1H221J	220pF 50V
C235,236	2554214049	CQ09P1H821J	820pF 50V
C237,238	2554216021	CQ09P1H682J	0.0068μF 50V
C243,244	2544260045	CE04W1H010M	1μF 50V
C245~248	2544260087	CE04W1H100M	10μF 50V
C249~252	2544260045	CE04W1H010M	1μF 50V
C253,254	2554121006	CQ93P1H101J	100μF 50V
C261,262	2561033019	CF93B2A105K	1μF/100V
C263,264	2544260087	CE04W1H100M	10μF 50V
C291,292	2544260087	CE04W1H100M	10μF 50V
C295,296	2561033035	CF93B2A474K	0.47μF 100V
<b>OTHER PARTS GROUP</b>			
L201,202	2350030100	LP.F COIL	
L203	2350016917	INDUCTOR (108K)	
RL201	2149005100	RELAY	
RL202	2140036000	REED RELAY	
RL203~206	2149005100	RELAY	

## KU-9105E ANALOG P.S. UNIT

Ref. No.	Part No.	Part Name	Remarks
SW003	2124187001	SLIDE SW	
SW004	2123626000	SLIDE SW REMOTE	
	2048236009	4P CONNECTOR	
	2048237008	BASE	
	2048237008	6P CONNECTOR	
	2048237008	BASE	
CN14,15,19	2050233032	3P EH	
	2050190052	CONNECTOR BASE	
	2050190052	5P NH	
	2050190052	CONNECTOR BASE	
C17~21	2050185038	3P WIRE HOLDER	
CN7~19	2050185041	4P WIRE HOLDER	
CN7	2050185054	5P WIRE HOLDER	
CN4	2050185067	6P WIRE HOLDER	
	2050243022	2P WIRE HOLDER	
CN4	2040094016	6P CONNECTOR	
	2040094016	CORD	
CN17	2034388000	3P CONNECTOR	
	2042213002	CORD	
	2042213002	9P CONNECTOR	
	2030225073	CORD	
	2090208001	1P CONTACT ASS'Y	
	2090208001	TWIN SHIELD	
	2090208001	WIRE	
	2034383018	3P CONNECTOR	
	2034383021	CORD	
	2034383021	3P CONNECTOR	
	2034426001	CORD	
	2034426001	3P CONNECTOR	
	2050414000	CORD	
	2050414000	1P CONNECTOR	
	2050414013	BASE	
	2050414013	1P CONNECTOR	
	2050414013	BASE	
	2050414026	1P CONNECTOR	
	2050414026	BASE	

Ref. No.	Part No.	Part Name	Remarks
<b>SEMICONDUCTOR GROUP</b>			
IC1	2630254004	NJM78M05A	
IC2	2630272002	NJM79M05A	
IC3	2630470008	AN78N24	
IC4	2630472006	AN79N24	
IC7,8	2630284003	M5219P	
TR11~18	2750060000	2SK-170BL	
TR19~26	2750059008	2SJ-74BL	
TR27,28	2730199001	2SC2238 (Y)	
TR29,30	2710104003	2SA968 (Y)	
TR31~34	2750055028	2SK184 (Y)	
LE1	3939319018	LD-701DU	
D1~8	2760247910	DSA1A2 (TYPE-3)	
D11~14	2760236031	HZ5C-1	
D15~17	2760049011	1S2076A	
<b>REGISTER GROUP</b>			
R15~18,23,24	2440017020	RS14B3A100JNBF	
VR1	2119047101	V2540V30SA503	50kΩA
VR2	2119048003	V16V20FB503T	50kΩB
VR11,12	2116025016	V08PB101	100ΩB
<b>CAPACITOR GROUP</b>			
C1~3	2538014003	CK45F2GAC103M	0.01μF 400VAC
C4	2551134025	CQ92M1H103J	0.01μF 50V
C5	2538014003	CK45F2GAC103M	0.01μF 400VAC
C6~7	2544254080	CE04W1C102M	1000μF 16V
C8~9	2544260087	CE04W1H100M	10μF 50V
C10~11	2544277009	CE04W1H222	2200μF 50V
C14,15	2561033019	CF93B2A105K	1μF 100V
C51~52	2554214078	CQ09P1H101J	100pF 50V
C53~56	2544260087	CE04W1H100M	10μF 50V
C57	2561033019	CF93B2A105K	1μF/100V
C58,59	2544260087	CE04W1H100M	10μF 50V
C60	2561033019	CF93B2A105K	1μF 100V
C61~64	2521008000	CM92C1H080D	8pF 50V
C65~68	2543054948	CE04D1E101MBP	100μF 25V
C403~406	2544195929	CE04W1V100M	10μF 35V
<b>OTHER PARTS GROUP</b>			
ΔL1	2398019002	LINE FILTER COIL	
L11,12	2350016917	INDUCTOR (180K)	
RL1~3	2419005100	RELAY	
ΔSW1	2129525008	POWER SW	
ΔF1	2061039047	FUSE 1.25A	
ΔF2,3	2061039034	FUSE 1A	
ΔF4,5	2061039050	FUSE 1.6A (T)	

Ref. No.	Part No.	Part Name	Remarks
ΔF1~5	2020022008	FUSE HOLDER	
TR27~30	4170253000	RADIATOR	
IC3	4170253026	RADIATOR	
	2048225007	2P CONNECTOR	
	2048225007	BASE	
	2048239007	4P CONNECTOR	
	2048239007	BASE	
CN1	2050243022	2P WIRE HOLDER	
CN16,18,19,20	2050185038	3P WIRE HOLDER	
CN13,14	2050243035	3P WIRE HOLDER	
CN12	2050185041	4P WIRE HOLDER	
-15-18			
CN2	2050190036	3P NH	
-17-18		CONNECTOR BASE	
CN18	2034389009	3P CONNECTOR	
	2034389009	CORD	
CN18	2034389012	3P CONNECTOR	
	2034389012	CORD	
CN19	2034380011	3P CONNECTOR	
	2034380011	CORD	
CN3	2050190036	3P NH	
-12-13		CONNECTOR BASE	
CN4	2050190065	6P NH	
	2050190065	CONNECTOR BASE	
CN1	2050233032	3PEH CONNECTOR	
	2050233032	BASE	
CN18	2050154030	3P NH	
	2050154030	CONNECTOR BASE	
CN19	2050234031	3PEH SID CON.	
	2050234031	BASE	
	2050141001	COMMON PLATE	
CN18	2030275081	1P CONTACT ASS'Y	
	2050414013	1P CONNECTOR	
	2050414013	BASE	
CN12	2034383005	3P CONNECTOR	
	2034383005	CORD	
CN13	2034384004	3P CONNECTOR	
	2034384004	CORD	
CN16	2034387001	3P CONNECTOR	
	2034387001	CORD	
CN19	2034386002	3P CONNECTOR	
	2034386002	CORD	
CN1	2034382006	3P CONNECTOR	
	2034382006	CORD	
CN20	2090208014	TWIN SHIELD	
	2090208014	WIRE	
CN12-15	2090207057	VINYL WIRE	

**KU-9116E SERVO UNIT**

Ref. No.	Part No.	Part Name	Remarks
IC901	2630229013	LA-6458DF	
<b>RESISTOR GROUP</b>			
R901~906	2412116001	RD14B2E103J	10kΩ (±5%) ¼W
<b>CAPACITOR GROUP</b>			
C901,902	2561033019	CF93B2A105K	1μF 100V
C903~906	2544261015	CE04W1H470M	47μF 50V
C909,910	2544260045	CE04W1H010M	1μF 50V
<b>OTHER PARTS GROUP</b>			
	2050190036	3P NH CONNECTOR BASE	
	2050233032	3P EH CONNECTOR BASE	
	2050142039	2P CONNECTOR BASE PIN	

**KU-9105D for E1**  
[Same as KU-9105E (for EU) except the followings]

Ref. No.	Part No.	Part Name	Remarks
<b>CAPACITOR GROUP</b>			
C002,003	2538014003	CK45F2GAC103M (2)	DELETE
<b>COIL GROUP</b>			
L001	2398019002	LINE FILTER COIL	DELETE
<b>OTHER PARTS GROUP</b>			
Δ F001	2061039047	FUSE 1.25A (1)	DELETE
		DELETE	
Δ F002,003	2061053007	FUSE 1.0A (2)	CHANGE
		FUSE 1.6A(T) (2)	
Δ F004,005	2061035054	FUSE 1.6A(T) (2)	
	2020022008	FUSE HOLDER (2)	DELETE
	2090207057	VINYL WIRE	CHANGE

**KU-9105B for E2**  
[Same as KU-9105E (for EU) except the followings]

Ref. No.	Part No.	Part Name	Remarks
<b>OTHER PARTS GROUP</b>			
Δ F001	2061015016	FUSE (1.25A) (1)	CHANGE
		CHANGE	
Δ F002,003	2061036008	FUSE STR30MA (2)	CHANGE
		CHANGE	
Δ F004,005	2061015058	FUSE 1.6A (2)	CHANGE
	4150298001	CONDENSER COVER (1) ADD (For C001)	

PRINTED WIRING BOARD

KU-9105 ANALOG P.S. UNIT

KU-9103B for E2  
 [Same as KU-9103E (for EU) except the followings]

Ref. No.	Part No.	Part Name	Remarks
OTHER PARTS GROUP			
F501~504	2061015016	FUSE (1.25A) (4) CHANGE	

KU-9103D for E1  
 [Same as KU-9103E (for EU) except the followings]

Ref. No.	Part No.	Part Name	Remarks
OTHER PARTS GROUP			
F501~504	2061035025	FUSE 1.25A (T) (4) CHANGE	
	2020022008	FUSE HOLDER (6) CHANGE	

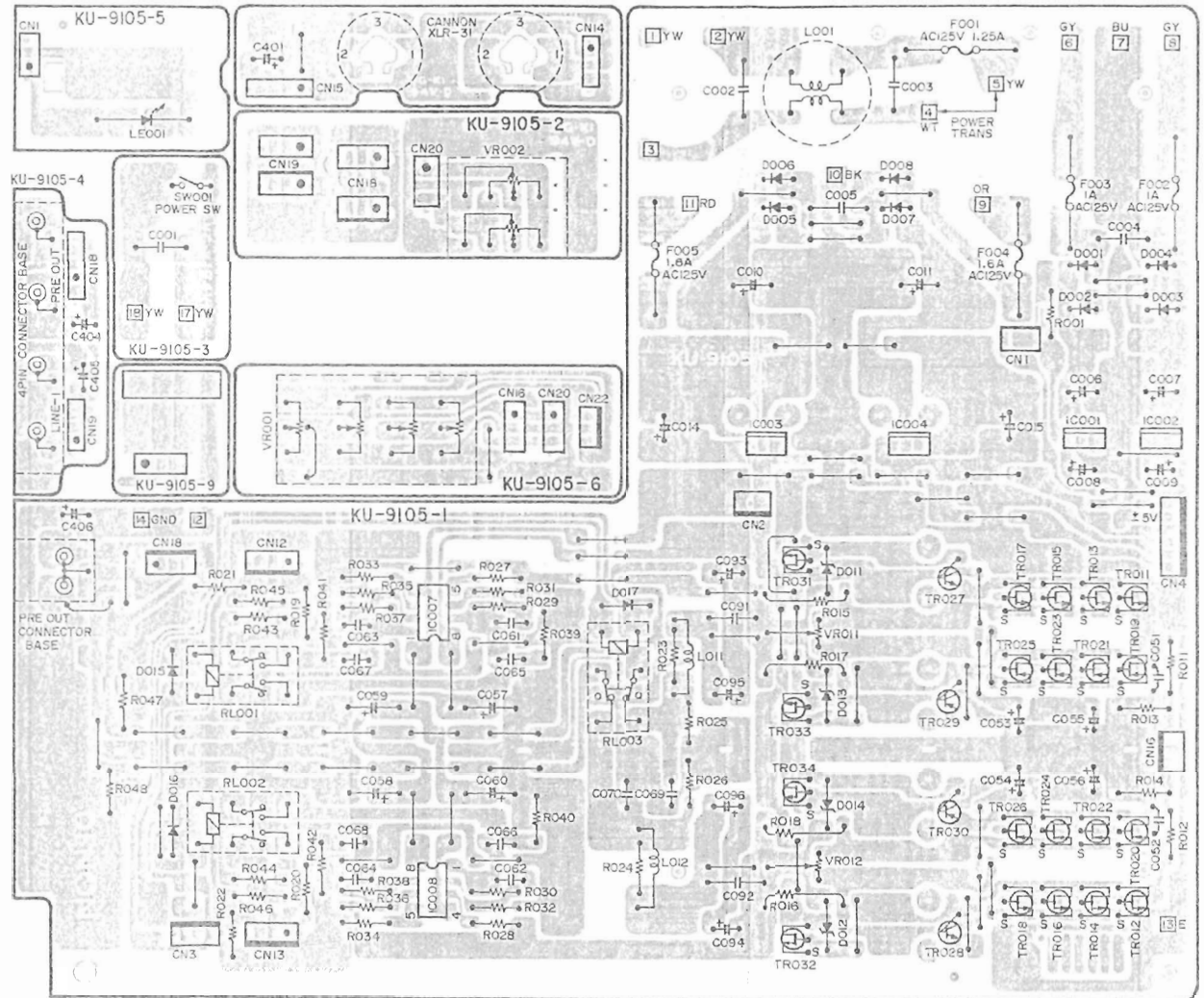



KU-9102 DIGITAL SIG UNIT

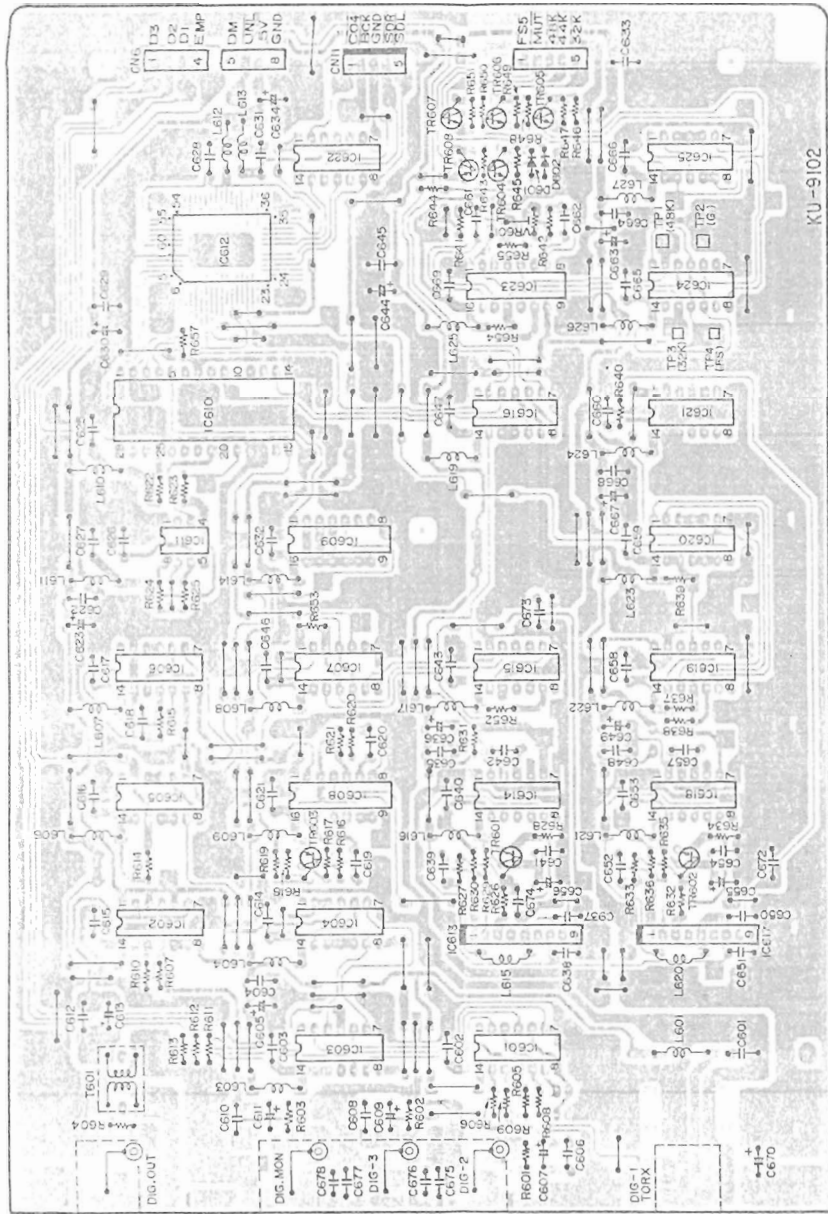

KU 9104 D.A. & INPUT UNIT

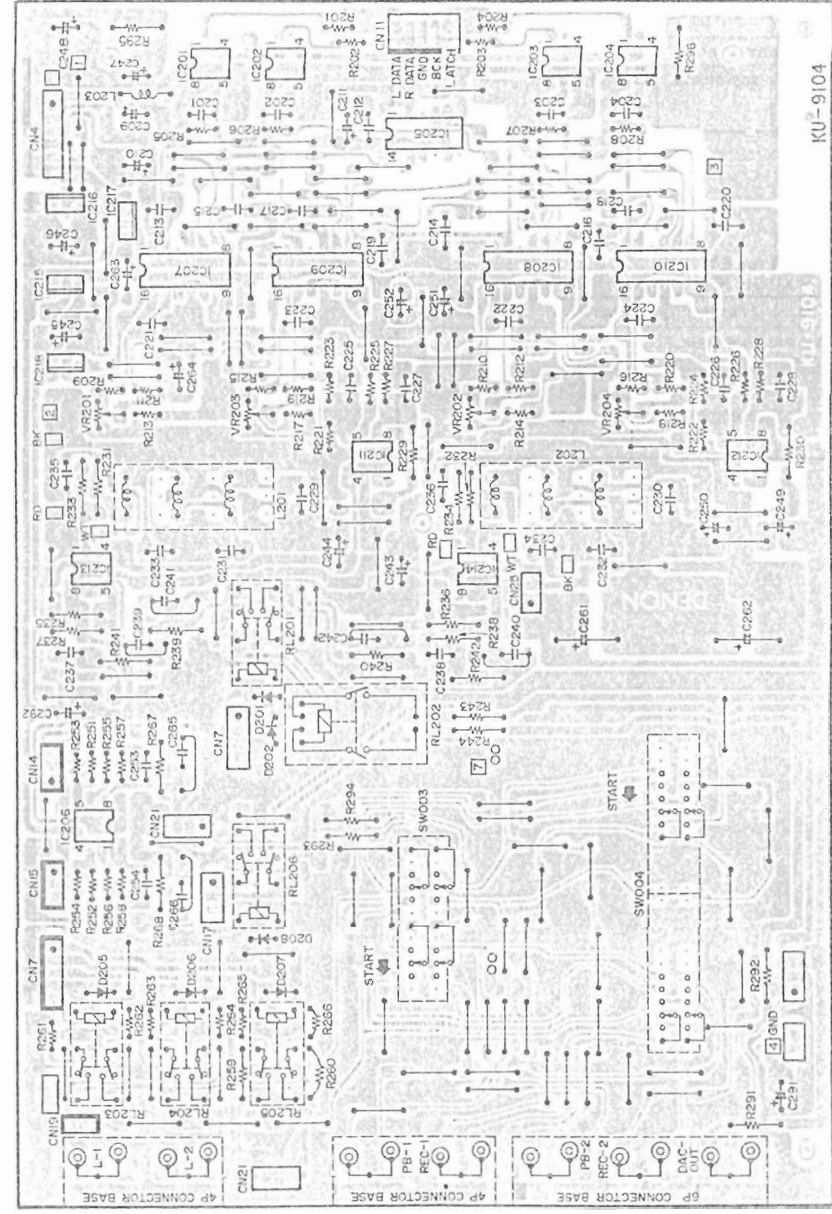

KU-9103 DIGITAL P.S. UNIT

KU-9116 SERVO UNIT

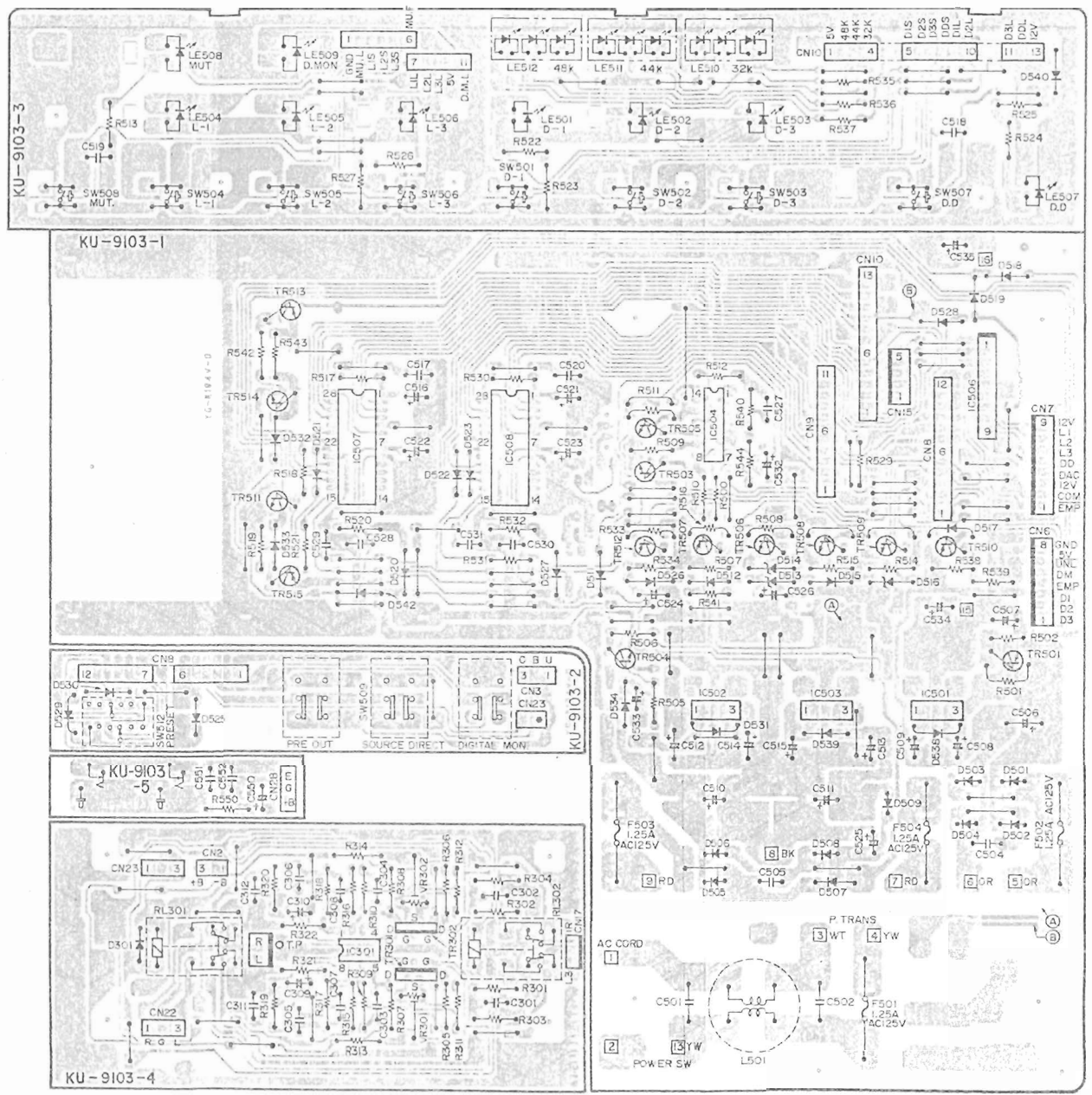
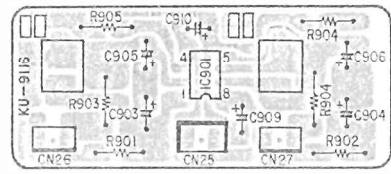



•PARTS LIST OF EXPLODED VIEW

Ref. No.	Part No.	Part Name	Remark
*1	KU-9102E	DIGITAL SIG UNIT	1
*2	KU-9103E	DIGITAL P.S UNIT	1
*3	KU-9104E	D.A & INPUT UNIT	1
*4	KU-9105E	ANALOG P.S UNIT	1
5	4119045305	SIDE CHASSIS (R)	1
6	4117048001	CENTER CHASSIS (R)	1
7	4149038104	SHIELD PLATE (A)	2
9	4610114007	CUSHION	1
10	4439015002	P.W. SPACER	6
11	4159016006	P.C.B HOLDER	9
12	4149017031	SAFETY PLATE	1
13	4119046003	SIDE CHASSIS (L)	1
14	4119047002	CENTER CHASSIS (L)	1
15	4119044209	FRONT CHASSIS	1
16	4129106001	BRACKET (B)	1
17	4129100104	VR BRACKET	1
18	4129101103	4 P.T BRACKET	1
19	4619001098	RUBBER SHEET	1
21	4121979003	P.C.B HOLDER	4
*23	1059091108	BACK PANEL	1
24	2050416008	3P CANNON CONNECTOR	2
25	2050388000	3P CANNON CONNECTOR	2
27	4129103004	TOP SUPPORT	2
28	4129102102	TORX SUPPORT	1
29	4159027008	SHIELD BRACKET	2
30	4450048016	CORD HOLDER (L50)	3
31	2038185005	5P CONNECTOR CORD	1
32	2123625027	ROTARY REMOTE	1
33	2123625014	ROTARY REMOTE	1
34	4450033005	WIRE CLAMP BAND	18
35	4149039200	SHIELD COVER	1
36	1059086100	BOTTOM COVER	2
37	1049010005	FOOT ASS'Y	4
Δ*39	2062039004	AC CORD (POLARIZED)	1
Δ*40	4450020005	CORD BUSH (4K-4)	1
Δ*41	2339568004	POWER TRANS (DIGITAL)	1
Δ*42	2339569003	POWER TRANS (ANALOG)	1
43	1469093204	ESC BAR (C)	1
44	4770284000	PLASTIC RIVET	2
45	1139071006	PUSH KNOB (T)	3
46	1469091002	BLIND SHEET (4P)	1
47	1129037005	KNOB ASS'Y	1
48	1129038004	KNOB ASS'Y	3
49	AF70A81	FRONT PANEL SUB ASS'Y	1
52	AS71B02	S-ESC SUB ASS'Y (R)	1
53	AS71B04	S-ESC SUB ASS'Y (L)	1
54	4210261004	MINI DAMPER	1
55	1449055107	DOOR	1
56	1220039038	SPACER	2
*57	1040034006	STOPPER	6
58	4010140215	HINGE (L)	1
59	4010139116	HINGE (R)	1
60	4250140114	BEARING	2
62	1139117106	DOOR KNOB	1
63	4630182080	SPRING	1
64	1229013039	SPACER	1

PARTS LIST OF PACKING & ACCESSORIES

Ref. No.	Part No.	Part Name	Remark
201	-	-	-
202	5040063060	STYLEN PAPER	1
203	5049102003	STYLEN PAPER	1
204	5059102006	POLY COVER	1
205	5039142002	CUSHION ASS'Y	1
206	5019128059	CARTON CASE	1
207	5058006019	ENVELOPE	1
208	5119213107	INST MANUAL	1
209	2048121004	2P PIN CORD	1
*210	5150418000	DAI WARRANTY HOME	1
211			
212			

ADDENDUM LIST

Ref. No.	Part Name & Descriptions	Part No.	
		E1	E2
1	DIGITAL SIG UNIT	KU-9102D	KU-9102B
2	DIGITAL P.S UNIT	KU-9103D	KU-9103B
3	D.A & INPUT UNIT	KU-9104D	KU-9104B
4	ANALOG P.S UNIT	KU-9105D	KU-9105B
23	BACK PANEL	1059095007	1059091111
Δ 39	AC CORD	2006031028	2062002031
Δ 40	CORD BUSH (4K-4)	4450028007	4450020005
Δ 41	POWER TRANS (DIGITAL)	2339573002	2339570005
Δ 42	POWER TRANS (ANALOG)	2339574001	2339571004
57	STOPPER	1040034006(2)	1040034006(2)
68	SIDE COVER	1029020002(2)	1029020002(2)
79	INSULATING SHEET	-	-
80	FUSE (1.25A) F901	2061035025	-
81	VOLTAGE SEL SWITCH	2129555007	-
82	FUSE BRACKET	4129139007	-
83	FUSE HOLDER	2020013101	-
101	TAPPING SCREW(S) 3x6 (BLACK)	4737002034(45)	4737002034(40)
210	DAI WARRANTY HOME	-	-

Note 1. See addendum list above for the parts with asterisk (\*) on the Ref. No. and the other parts not included in the list.  
 2. \* marked not included EXPLODED VIEW OF CHASSIS AND CABINET.  
 3. This list is prepared based on EU BLACK VERSION.

WIRING DIAGRAM  
(This figure is specifications of EU)

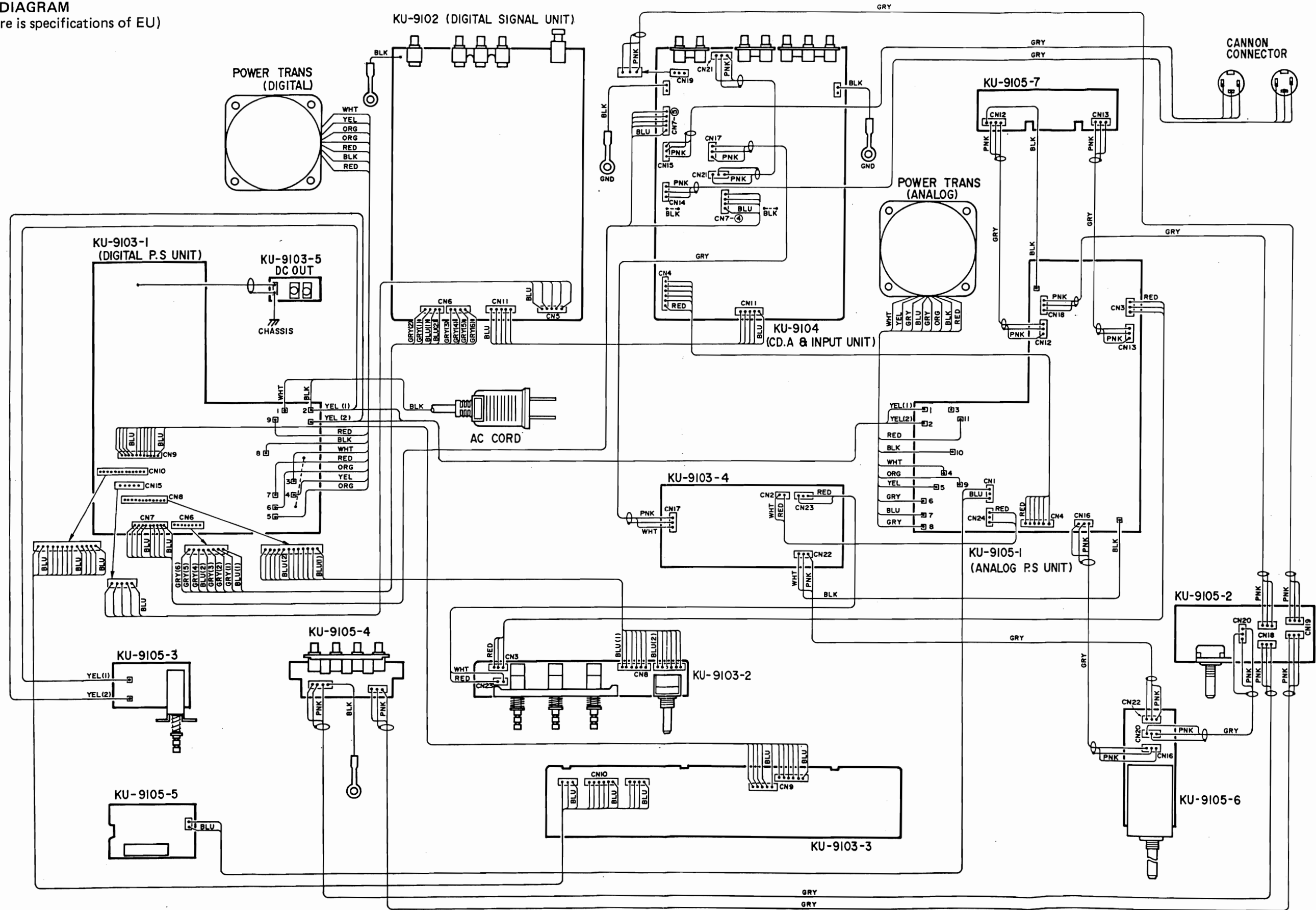

SCHEMATIC DIAGRAM (ANALOG UNIT)

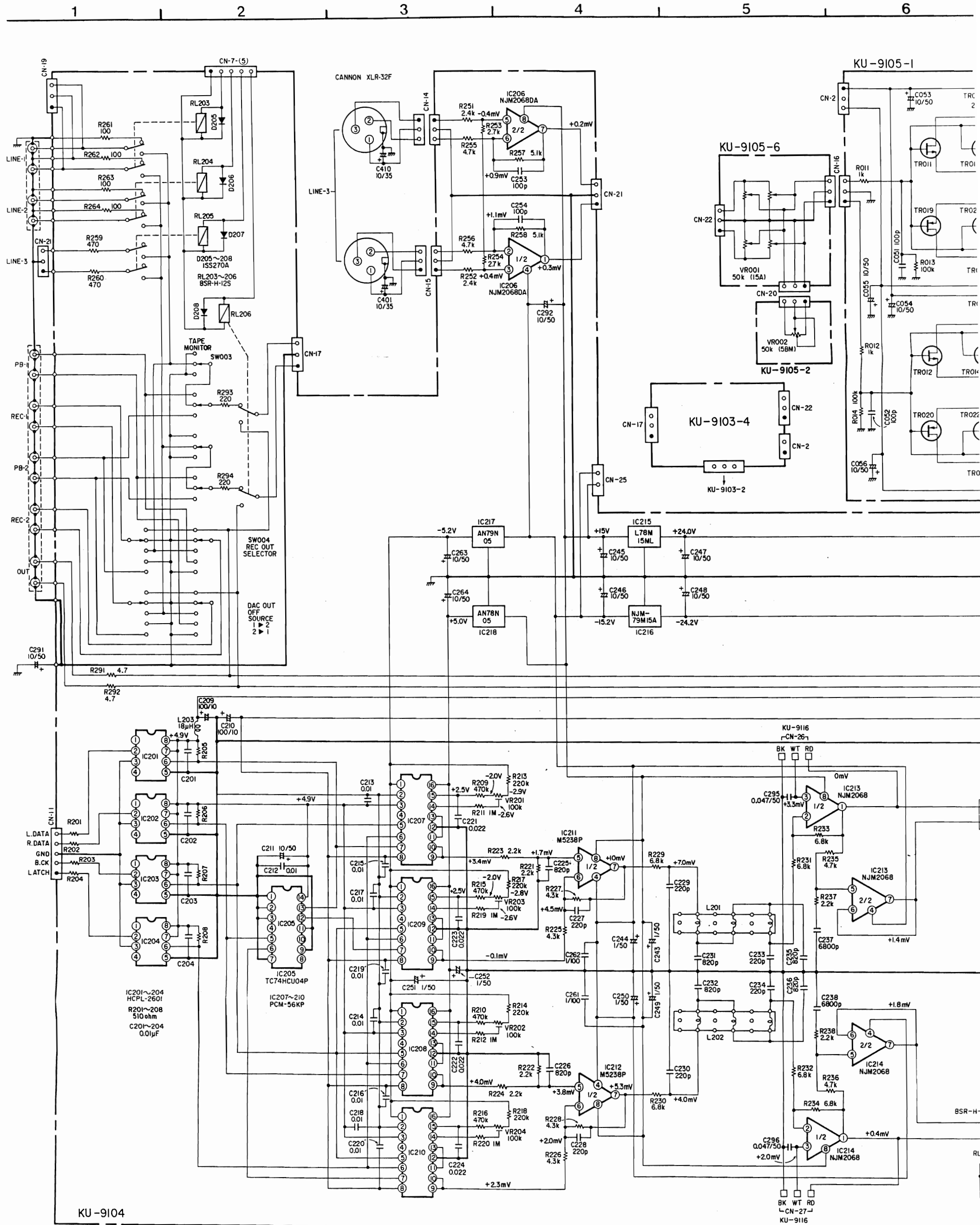

Means important safety item, which must be replaced, when necessary, by a part specified or meeting the specification by the manufacturer.

5 6 7 8 9 10

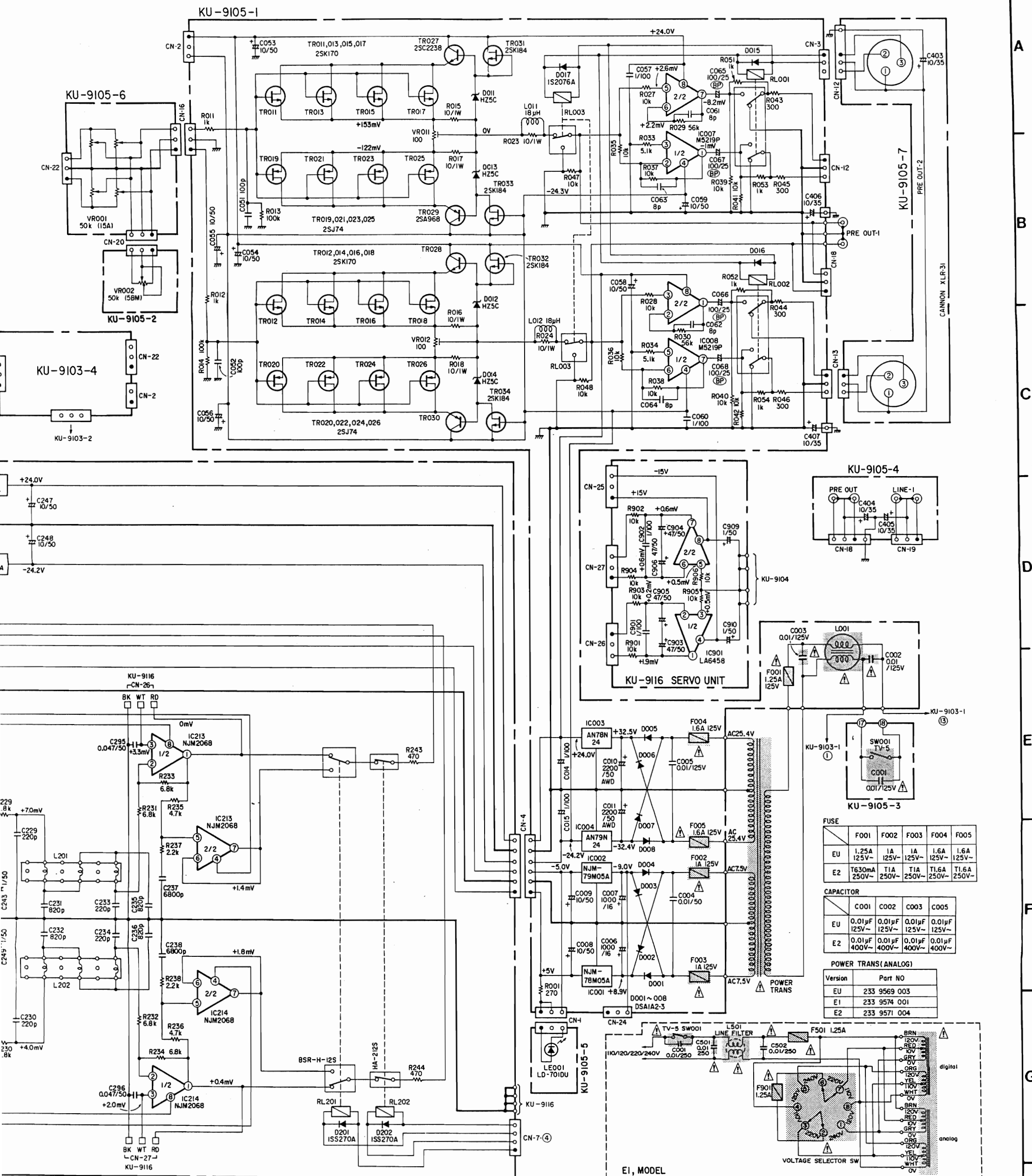

FUSE	F001	F002	F003	F004	F005
EU	1.25A 125V~	1A 125V~	1A 125V~	1.6A 125V~	1.6A 125V~
E2	T630mA 250V~	T1A 250V~	T1A 250V~	T1.6A 250V~	T1.6A 250V~

CAPACITOR	C001	C002	C003	C005
EU	0.01µF 125V~	0.01µF 125V~	0.01µF 125V~	0.01µF 125V~
E2	0.01µF 400V~	0.01µF 400V~	0.01µF 400V~	0.01µF 400V~

POWER TRANS (ANALOG)	
Version	Part NO
EU	233 9569 003
E1	233 9574 001
E2	233 9571 004

NOTES  
 ALL RESISTANCE VALUES IN OHM k = 1,000 OHM M = 1,000,000 OHM  
 ALL CAPACITANCE VALUES IN MICRO FARAD P = MICRO-MICRO FARAD  
 EACH VOLTAGE AND CURRENT ARE MEASURED AT NO SIGNAL INPUT CONDITION.  
 CIRCUIT AND PARTS ARE SUBJECT TO CHANGE WITHOUT PRIOR NOTICE.





⚠ Means important safety item, which must be replaced, when necessary, by a part specified or meeting the specification by the manufacturer.

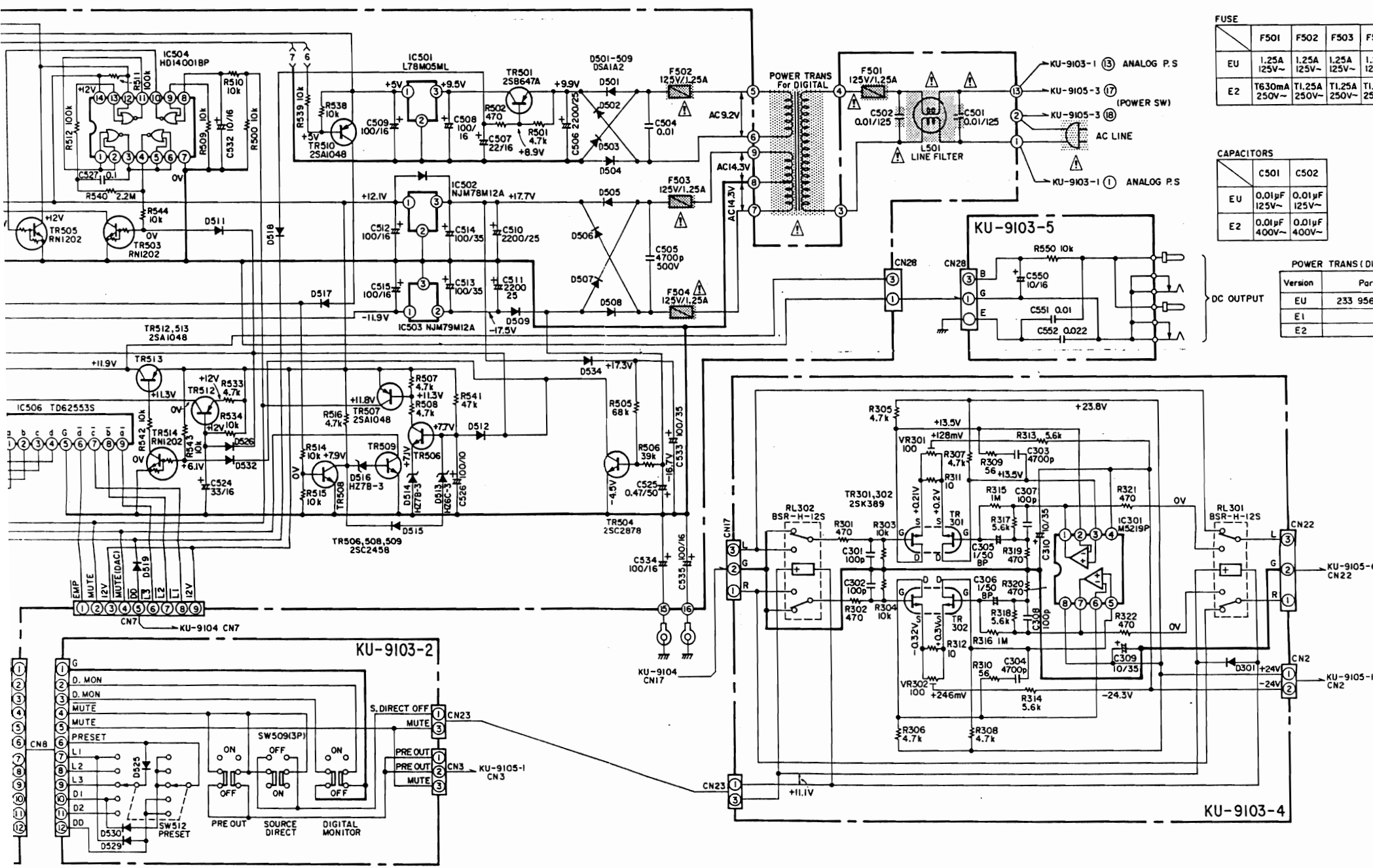
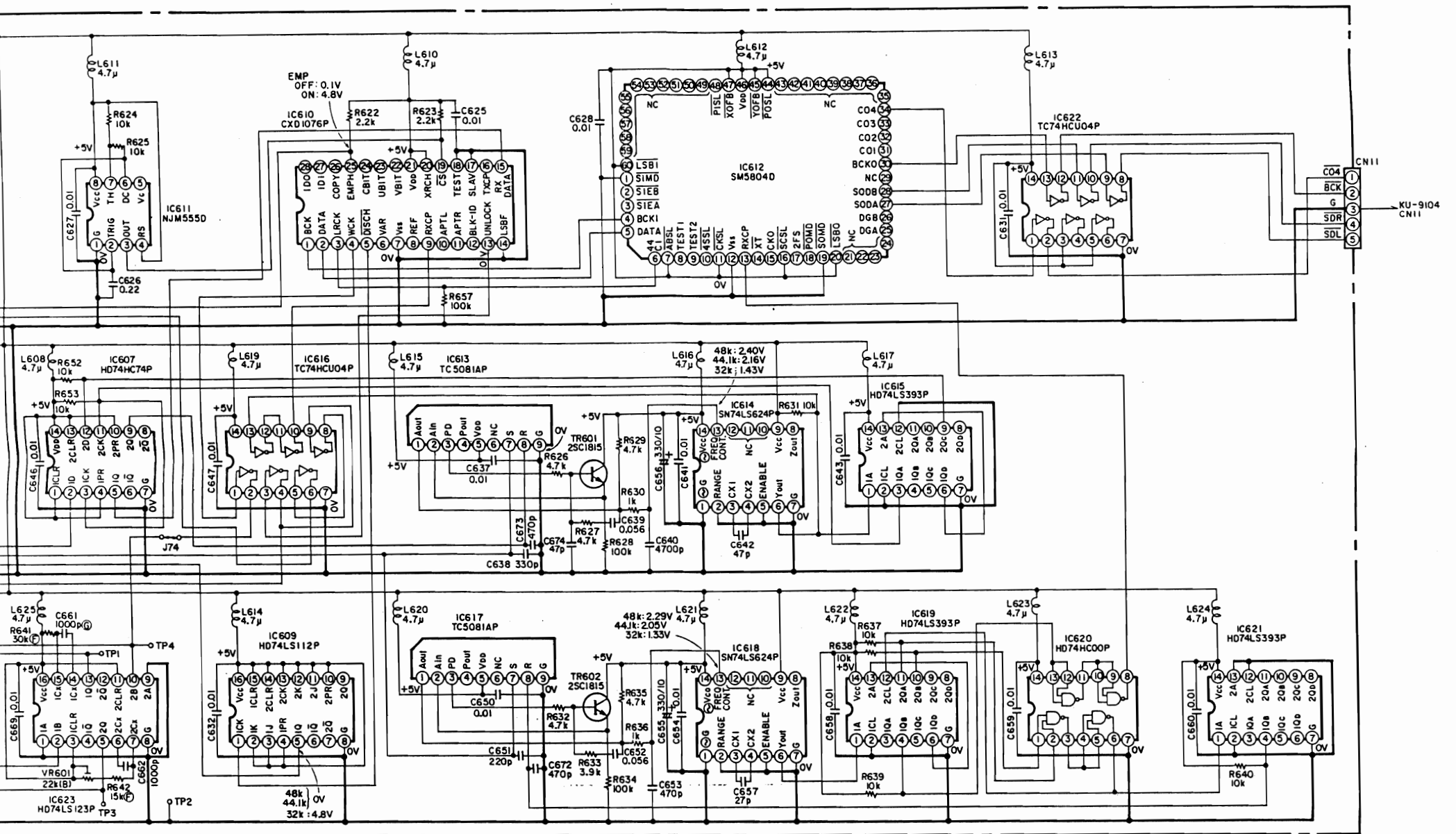

FUSE

	F501	F502	F503	F504
EU	1.25A 125V~	1.25A 125V~	1.25A 125V~	1.25A 125V~
E2	T6.30mA 250V~	T1.25A 250V~	T1.25A 250V~	T1.25A 250V~

CAPACITORS

	C501	C502
EU	0.01µF	0.01µF
E2	0.01µF	0.01µF

POWER TRANS (DIGITAL)

Version	Part NO
EU	233 9568 004
E1	
E2	

NOTES  
 ALL RESISTANCE VALUES IN OHM k = 1,000 OHM M = 1,000,000 OHM  
 ALL CAPACITANCE VALUES IN MICRO FARAD P = MICRO-MICRO FARAD  
 EACH VOLTAGE AND CURRENT ARE MEASURED AT NO SIGNAL INPUT CONDITION.  
 CIRCUIT AND PARTS ARE SUBJECT TO CHANGE WITHOUT PRIOR NOTICE.

**WARNING:****1. Component parts**

Parts marked with  and/or shading in this service manual have special characteristics important to safety. Be sure to use the specified parts for replacement.

**2. Leakage current**

Before returning the appliance to customer, test the leakage current when the power plug is connected. Use a calibrated (with an error of not more than 5%) leakage current tester and measure the leakage current from any exposed metal to the earth ground. Reverse the power plug polarity and test the above again.

Any current measured **MUST NOT EXCEED 0.5 milliamps**. Corrective measure must be taken if it exceeds the limit.



**CAUTION**  
RISK OF ELECTRIC SHOCK  
DO NOT OPEN



**CAUTION: TO REDUCE THE RISK OF ELECTRIC SHOCK, DO NOT REMOVE COVER (OR BACK). NO USER SERVICEABLE PARTS INSIDE. REFER SERVICING TO QUALIFIED SERVICE PERSONNEL.**



The lightning flash with arrowhead symbol within an equilateral triangle is intended to alert the user of the presence of uninsulated "dangerous voltage" within the product's enclosure that may be of sufficient magnitude to constitute a risk of electric shock to persons.



The exclamation point within an equilateral triangle is intended to alert the user of the presence of important operating and maintenance (servicing) instruction in the literature accompanying the appliance.

**WARNING: TO PREVENT FIRE OR SHOCK HAZARD.  
DO NOT EXPOSE THIS APPLIANCE TO RAIN OR MOISTURE.**